



# LENS PRODUCT DESCRIPTION STANDARD

VERSION 1.00

September 2023

©2023 The Vision Council

**Developed by:**

**Lens Division of The Vision Council**

**Lens Product Description Standard Committee**

The Vision Council

225 Reinekers Lane Suite 700

Alexandria, VA 22314

[thevisioncouncil.org](http://thevisioncouncil.org)

# Lens Product Description Standard

Version 1.00, September 2023

## Table of Contents

---

<b>1.</b>	<b>Foreword</b>	<b>2</b>
<b>2.</b>	<b>Definitions and Sign Convention</b>	<b>4</b>
<b>3.</b>	<b>Describing Lens Products</b>	<b>13</b>
<b>4.</b>	<b>Standard File Format Examples</b>	<b>36</b>
<b>5.</b>	<b>Literal Abbreviations</b>	<b>42</b>
<b>6.</b>	<b>Base Curve Charts</b>	<b>46</b>
<b>7.</b>	<b>Describing the Geometry of Non-Spherical Surfaces</b>	<b>50</b>

# 1 Foreword

## 1.1 Scope and Purpose

This Standard addresses the need for an industry-wide data file structure and related terminology. It is for use by lens manufacturers and designers in describing the technical attributes of lens products. Suppliers of laboratory lens layout software use this data in the selection and processing of prescription lenses. Data describing the front surface geometry of non-spherical lenses is included to enable accurate control of lens thickness. Additional information required for the production of an individualized product design can be described through the inclusion of parameters. This standard replaces the many proprietary file formats currently in use when supplying software vendors with lens specifications in electronic form.

The purpose of this Standard is:

- Provide a consistent method and nomenclature for describing the specifications and attributes of both finished and semi-finished spectacle lens blanks as supplied by the lens vendor
- Provide a consistent and precise method for describing the geometry of non-spherical lens surfaces, including aspheric and progressive lens surfaces, to ensure accurate control of lens thickness during prescription processing.
- Provide an extensible way to fully describe all technical and non-technical requirements about a design that may be required to create an individualized product for a patient.

## 1.2 Normative References

The following normative references contain additional terms, guidelines, optical & geometrical tolerances, and test methods that are applicable to this Standard. Wherever possible, the terms and guidelines presented in this Standard have been written in accordance with these references:

*Standard for Device Communications*, Vision Council

ANSI Z80.1, For Ophthalmic Optics — *Prescription Ophthalmic Lenses — Recommendations*, American National Standards Institute

ISO 10322-1, Ophthalmic Optics — *Semi-finished spectacle lens blanks: Specifications for single-vision and multifocal lens blanks*, International Standards Organization

ISO 10322-2, Ophthalmic Optics — *Semi-finished spectacle lens blanks: Specifications for progressive power lens blanks*, International Standards Organization

ISO 8980-1, Ophthalmic Optics — *Uncut finished spectacle lenses: Specifications for single-vision and multifocal lenses*, International Standards Organization

ISO 8980-2, Ophthalmic Optics — *Uncut finished spectacle lenses: Specifications for progressive power lenses*, International Standards Organization

### **1.3 Changes from prior version**

Initial release

## 2 Definitions and Sign Convention

### 2.1 Glossary of technical terms and definitions

Throughout this Standard, the following terms, definitions, and abbreviations shall apply. Wherever possible, these definitions are consistent with ANSI and ISO definitions.

- 2.1.1 **ABBE VALUE** (abbr. **ABBE**): The Abbe value is the reciprocal of the relative dispersion of a lens material, and is a measure of the ability of the material to refract light into its various component wavelengths (or colors). The Abbe value  $\eta_d$ , is defined by the following formula:

$$v_d = \frac{\eta_d - 1}{\eta_F - \eta_C}$$

where  $\eta_d$  is the index of refraction of the helium d-line (587.56 nm),  $\eta_F$  is the index of refraction of the hydrogen F-line (486.13 nm), and  $\eta_C$  is the index of refraction of the hydrogen C-line (656.27 nm).

- 2.1.2 **BASE CURVE, NOMINAL** (abbr. **BASE**): The standard or reference curve in a lens or series of lenses, for example the manufacturer's marked or nominal tool surface power of the finished surface of a semi-finished spherical lens.
- 2.1.3 **CENTER, OPTICAL**: The point on the front surface of a lens intersected by the optical axis of the lens. This point is free from prismatic effects.
- 2.1.4 **CURVATURE, INSTANTANEOUS RADIUS OF** (abbr. **RAD**): The instantaneous radius of curvature, measured in millimeters (mm) is the radius of curvature specified by the manufacturer for power calculations.
- 2.1.5 **DENSITY**: The mass per unit volume of a lens material. For the purposes of this Standard, density should be expressed in units of grams per cubic centimeter (g/cc). Density—when expressed in this manner—is equivalent to specific gravity, which is a unit-less expression comparing a given volume of the material to an equal volume of water.
- 2.1.6 **DIOPTER**: A unit of measurement in inverse meters (plus or minus) used to express the power of a lens or lens surface. The symbol 'D' is used to designate the diopter.
- 2.1.7 **DIOPTER, PRISM**: A unit of measurement used to express the angle of deviation of a ray of light by a prism or lens. Prism power, in these units, is measured as the displacement of the ray, in centimeters, perpendicular to its line of incidence at a distance of one meter. The symbol  $\Delta$  is used to designate the prism diopter.
- 2.1.8 **ENCROACHMENTS**: Any markings, physical alterations, or lenticular zones/ lips on a lens blank that may interfere with the optically usable area of the lens, unless otherwise defined.

- 2.1.9 FILTER: A lens material, treatment, or coating that absorbs, in whole or in part, some wavelengths of visible or near visible radiation while transmitting others.
- 2.1.10 FITTING CROSS (abbr. FC): That point on a lens as specified by the manufacturer to be used as a reference point for positioning the lens in front of a patient's eye.
- 2.1.11 INDEX OF REFRACTION (abbr. INDEX): The ratio of the velocity of light (with a given wavelength) in air to that in a medium. This ratio expresses the ability of a lens material to refract or bend a ray of light. The index of refraction is given for a specified reference wavelength.
- 2.1.12 INTERMEDIATE (abbr. INT): For the purposes of this Standard, the area in a trifocal lens that has been designed and manufactured to correct vision at intermediate ranges. This is generally the upper segment of two.
- 2.1.13 LENS(ES)
- 2.1.13.1 ASPHERIC: A lens in which one or both surfaces are aspheric.
- 2.1.13.2 BIFOCAL: A multifocal lens designed to provide correction for two discrete distances.
- 2.1.13.3 BLENDED: A multifocal lens designed to provide correction for specific discrete viewing distances without sharply defined borders between optical areas.
- 2.1.13.4 FINISHED: A lens finished to its final form, including vertex powers and thickness.
- 2.1.13.5 LENTICULAR: A lens, usually of strong refractive power, in which the prescribed power is provided over only a limited central region of the lens, called the optical portion. The remainder of the lens is called the carrier and provides no refractive correction but gives dimension to the lens for mounting, called the lenticular portion.
- 2.1.13.6 MINUS: A lens having negative refractive power. It is thinner at the center than at the edge and causes the divergence of a collimated beam of light.
- 2.1.13.7 MULTIFOCAL: A lens designed to provide correction for two or more discrete distances.
- 2.1.13.8 PLUS: A lens having positive refractive power. It is thicker at the center than at the edge and causes the convergence of a collimated beam of light.
- 2.1.13.9 PROGRESSIVE: A lens designed to provide correction for more than one viewing distance in which the power changes continuously rather than discretely.
- 2.1.13.10 SEMI-FINISHED: A lens having only one surface finished to a specific curve.

- 2.1.13.11 SINGLE VISION: A lens designed to provide correction for a single viewing distance.
- 2.1.13.12 SPHERICAL POWER: A lens that has the same refractive power in all meridians.
- 2.1.13.13 SPHERO-CYLINDER: A lens having different refractive power in the two principal meridians. It is sometimes referred to as an astigmatic or toric lens or, commonly though imprecisely, as a cylinder lens.
- 2.1.13.14 TRIFOCAL: A multifocal lens designed to provide correction for three discrete viewing distances.
- 2.1.14 MERIDIAN: A line of intersection of a surface with a plane perpendicular to that surface at a specified point. When applied to a lens, it may also be defined as a plane that contains the optical axis.
- 2.1.15 POWER
- 2.1.15.1 ADDITION (abbr. ADD): The difference in vertex power measurements between the near and distance reference points. The vertex (either front or back) of the surface containing the segment or addition is used.
- 2.1.15.2 CYLINDER (abbr. CYL): The difference (plus or minus) between powers measured in the two principal meridians of a sphero-cylinder lens. For the purposes of this Standard, cylinder power is the difference between the back vertex power measurements of the two principal meridians, as measured at the distance reference point of the lens blank.
- 2.1.15.3 PRISM: The ability of a prism or a lens to deviate a ray of light transmitted through it. It is the deviation of a ray normal to the back surface of a lens and penetrating the front surface at a specified point. The amount of deviation is expressed in prism diopter units.
- 2.1.15.4 REFRACTIVE SURFACE: The refractive surface power ( $F_s$ ) of a lens surface bounded by air is a measure of its ability to change the vergence of a beam of incident light and is defined as follows:

$$F_s = \frac{\eta_d - 1}{r}$$

where  $\eta_d$  is the index of refraction of the lens material using the helium d-line as the reference wavelength and  $r$  is the radius of curvature of the refracting surface in millimeters.

- 2.1.15.5 SPHERE (abbr. SPH): In a spherical lens, the dioptric power of a lens. In a sphero-cylinder lens, the sphere power is located in the cylinder axis meridian, which is the meridian containing the least minus or most plus power. For the purposes of this Standard, sphere power is the back vertex power measurement of the sphere principal meridian, as measured at the distance reference point of the lens blank.

2.1.15.6 VERTEX: The inverse of the distance, expressed in meters, from either the front or back lens vertex to the corresponding focal point of the reference wavelength. This is expressed in diopters. In a distance prescription, the spherical component of power and the cylindrical component of power are always expressed in terms back vertex power. The add power is generally expressed in terms of front vertex power for most multifocal lenses. The back vertex power  $F_V$  is defined using the equation:

$$F_V = \frac{F_1}{1 - \frac{t}{\eta_d} F_1} + F_2$$

where  $F_1$  and  $F_2$  are the front and back surface powers (respectively),  $t$  is the center thickness of the lens in meters, and  $\eta_d$  is the index of refraction of the lens material.

#### 2.1.16 REFERENCE POINT

2.1.16.1 DISTANCE (abbr. DRP): That point on a lens as specified by the manufacturer at which the distance sphere power, cylinder power, and axis shall be measured.

2.1.16.2 LAYOUT (abbr. LRP): That point on a lens as specified by the manufacturer that is used as a reference point for positioning the lens in front of the wearer's eye. For progressive addition lenses, the LRP is coincident with the fitting cross (FC). For conventional multifocals, the LRP is coincident with the location of the segment. For single vision lenses, the LRP is the geometric center (GC) of the lens blank, unless otherwise specified (e.g., decentered single vision aspheric lenses).

2.1.16.3 NEAR (abbr. NRP): That point on a multifocal or progressive lens as specified by the manufacturer at which the addition power is measured.

2.1.16.4 PRISM (abbr. PRP): That point on a lens as specified by the manufacturer at which the prism value of the finished lens is to be measured. For progressive lenses, the prism reference point is located at the midpoint between the semi-visible alignment reference markings (or "engravings"), separated by a distance of 34 mm, along a horizontal axis bisecting those two markings. For non-aspheric single vision and multifocal lenses, the prism reference point and distance reference point are assumed to be coincident.

2.1.17 REFERENCE WAVELENGTH: The reference wavelength used in the United States and in this Standard is the helium d-line (at 587.56 nm). For the purposes of this Standard, surface power, vertex power, and Abbé value should be provided using the helium d-line reference system. The mercury e-line (at 546.07 nm) is also used as a reference wavelength in some countries.

2.1.18 SAGITTA (abbr. SAG): The height or depth of a curve at a given diameter.



- 2.1.19 SEGMENT (abbr. SEG): A specified area of a multifocal lens having a different refractive power from the distance portion. This may also refer to the actual piece of material added to the lens in the case of a fused or cemented multifocal lens.
- 2.1.20 SLAB-OFF and REVERSE SLAB-OFF (abbr. SLAB): A prismatic component incorporated by bicentric grinding or molding into the lower portion of an ophthalmic lens to modify the amount of vertical prism for a line of sight through that portion of the lens.
- 2.1.21 SPECIFIC GRAVITY: See Density.
- 2.1.22 SURFACE
- 2.1.22.1 ASPHERIC: A non-spherical surface that is rotationally symmetrical with respect to an axis of symmetry. Such surfaces typically have continuously variable curvatures from the vertex to the periphery.
- 2.1.22.2 ATORIC: A surface having mutually perpendicular principal meridians of unequal power where at least one principal meridian has a non-circular section. These surfaces are symmetrical with respect to both principal meridians.
- 2.1.22.3 FREEFORM: A surface with no axis of symmetry, the local atoricity may change from point to point in the surface.
- 2.1.22.4 SPHERICAL: A curved surface having the same radius of curvature in all meridians.
- 2.1.22.5 TORIC: A surface in the form of a torus having different powers in the two principal meridians. The shape may be visualized as a small part of the surface of a doughnut or of a football. A toric surface is generated by rotating an arc of a circle around an axis which does not pass through the center of the circle.

## 2.2 Sign convention

The following sign convention and numerical precision is used throughout this Standard:

- For the purposes of this Standard, **numerical values** refer to either *floating point numbers* or *integers* (when no decimal precision is required), **text entries** refer to *character* or *string* data, and **literals** refer to designated, predefined combinations of characters having a specified length.
- Unsigned ( $\pm$ ) numerical values shall be interpreted as being positive (+).
- Negative (-) numerical values shall include a minus (-) sign in all field entries.
- Convex front curves and concave back curves shall require a positive (+) radius.
- Concave front curves and convex back curves shall require a negative (-) radius.

- Numeric fields may or may not contain a decimal point. If a decimal point is present, hosts and devices should be able to correctly parse any degree of precision, including zero.

## 2.3 Node terms and definitions

- 2.3.1 **PRODUCTS:** A product consists of a design and the combinations of lens blanks and treatments in which it is available. Parameters for each combination can be defined with specifics such as the sphere range for a given material and treatment combination.
- 2.3.2 **PRODUCT COLLECTIONS:** A product collection serves to identify a group of products that all share a release, such as a yearly release of a new branded product line.
- 2.3.3 **DESIGNS:** A design describes characteristics of the finished product, as well as indicating parameters that may influence individualized features of the design.
- 2.3.4 **LAYOUTS:** A layout details features such as PRP, NRP, ERP, LRP and Segment geometry details. The fields used to describe these features are taken from the DCS standard.
- 2.3.5 **MATERIAL RANGES:** A lens design may choose to specify a material range, rather than a specific material, upon which that design may be produced. This allows a lens designer to accommodate applying a design on multiple materials, branded or unbranded, without having to identify the individual material on which the design can be produced.
- 2.3.6 **MATERIALS:** Materials define substrates, including characteristics such as Refractive index, ABBE number and density.
- 2.3.7 **TREATMENTS:** Treatments detail the type, subtype, and branding of a given lens treatment. An example is a treatment of type Coating with sub type of Scratch Resistance (SR).
- 2.3.8 **PARAMETERS:** Parameters describe a data requirement that is associated with a particular object. This can be used to describe features such as the allowable range of a particular DCS field.
- 2.3.9 **PARAMETER COLLECTIONS:** This aggregation of parameters allows for a single identifier to be used in multiple locations, rather than requiring repetitious use of individual parameter identifiers.
- 2.3.10 **BLANKS:** A blank is a physical lens blank (semi-finished or finished) from which a lens product is produced. A blank with its inherent front and back surface features does not necessarily have a corresponding product; as is the case when intended to be sold without having another design applied to it.

2.3.11 BLANK COLLECTIONS: This serves as an aggregation of related blanks. Blanks within a collection will have shared features such as material, design, and treatments.

2.3.12 OWNERS: An owner provides information such as the branding and contact details of a manufacturer.

2.3.13 BASE CURVE CHARTS: Base curve charts provide a compressed representation of typical base curve charts to use when selecting blanks for a given prescription.

2.3.14 SAG CHARTS: Sag charts provide a method for describing the front surface of cast lens blanks, including aspheric and progressive addition lens surfaces

## 2.4 XML Data Structure Diagram

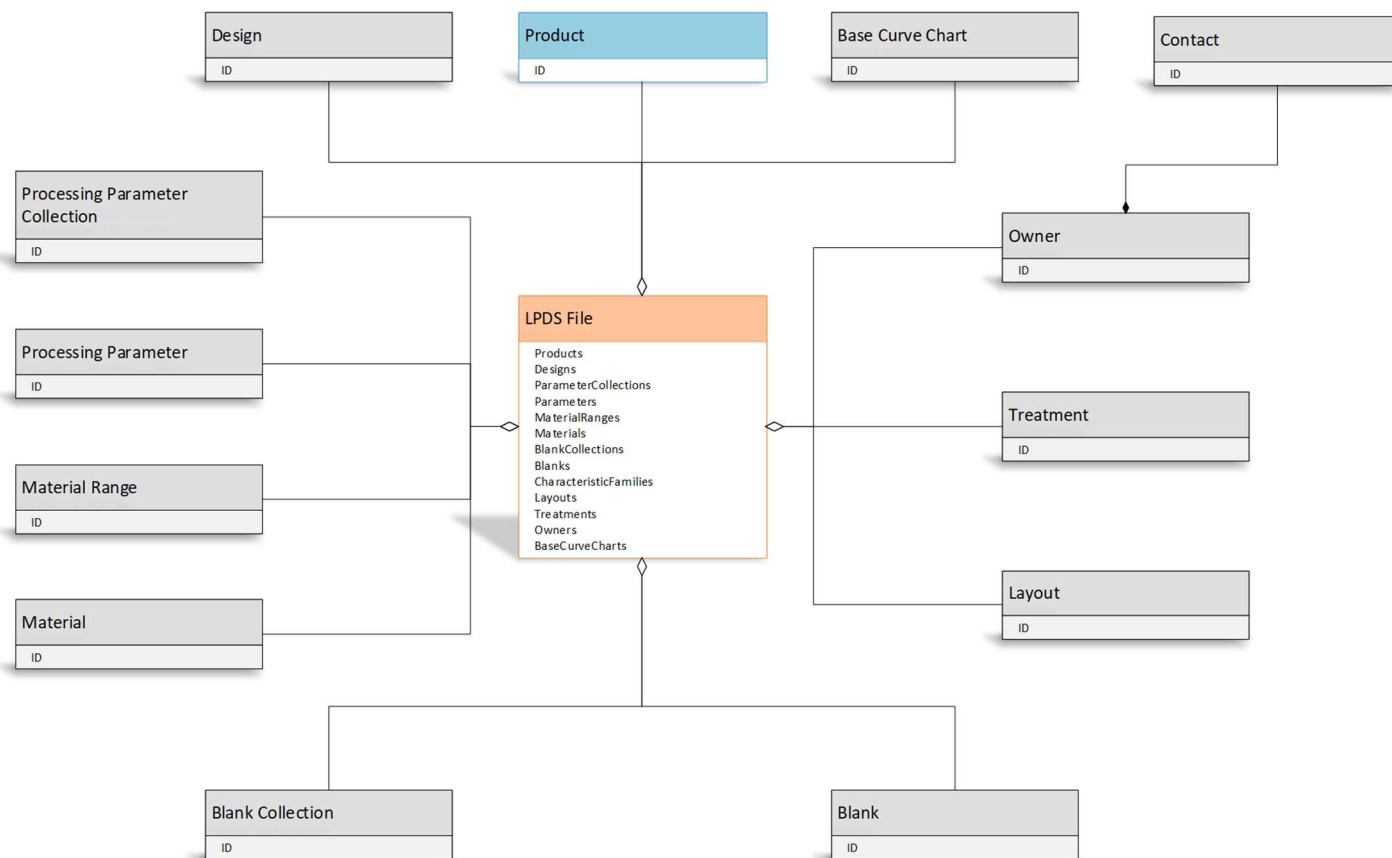

## 2.5 Element Reference Diagram

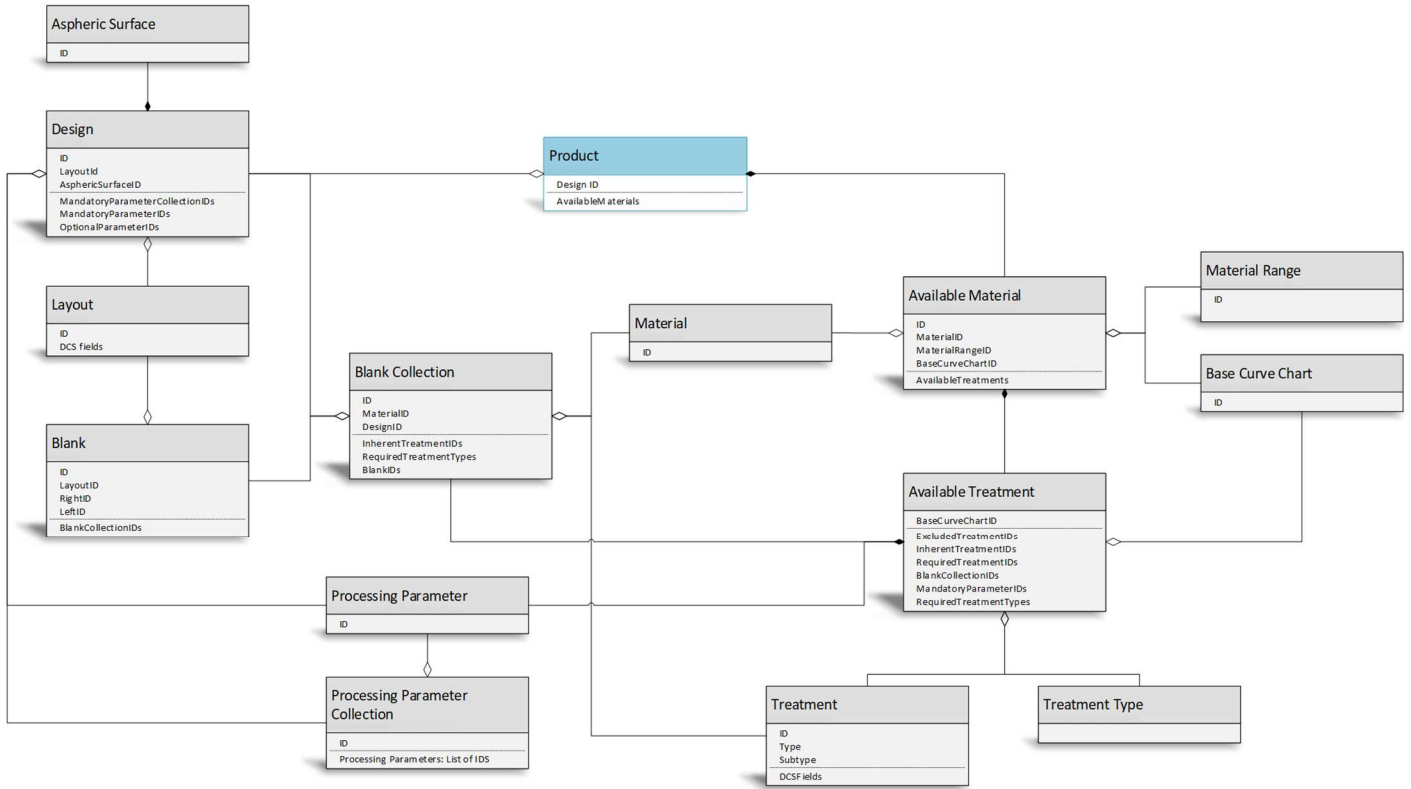

### 3 Describing Lens Products

The optical and geometrical (physical) attributes of a lens product shall be described using the format and conventions specified below. Records for new products, deleted products, and/or modified products may be provided in incremental form within a separate file, though files should aim to be inclusive of nodes identified by reference.

#### 3.1 Format Considerations

The Standard described herein shall be constrained to the requirements of XML 1.0 (fifth edition). The Standard leverages this format to maximize extensibility and interoperability.

#### 3.2 Owner Identifier

Owner identifiers are maintained by The Vision Council and can be added to as needed. Current owner identifiers can be found in Owner Abbreviations in section 5.2.

#### 3.3 Data Type Naming

These specialized data formats are present in section 3.6, and used for certain fields as necessary.

- 3.3.1 CBCR : Condensed Base Chart Range with the format: "Sph, Cyl, Base" (e.g. "-950,-262,null").
- 3.3.2 NRS : Number Range String with the format: "Start number: Increment: End number" (e.g. "-8:-2:-12"). If the increment value is null, then the range is continuous (e.g. "-8::-12").
- 3.3.3 GUID : A globally unique identifier, comprised of a string of 32 hexadecimal digits, in a format of 8-4-4-4-12 ("xxxxxxxx-xxxx-xxxx-xxxx-xxxxxxxxxxxx"), with matching hyphens. Alpha characters shall be lowercase.
- 3.3.4 ISODATE : A date string, formatted according to ISO 8601.
- 3.3.5 String (x) represents a string value limited to a length of 'x' characters. The lack of the specified length means that the string has no maximum length.
- 3.3.6 A data type indicating a collection of objects is represented with curly braces surrounding the object name (ie. "{BaseCurveChart}").
- 3.3.7 A data type indicating a collection of referenced identifiers is represented with square brackets surrounding the identifier name (ie. "[ParameterID]").

Data Type	Description	Literals
DCSDT	DCS Data Type:	

Data Type	Description	Literals
	Number without decimal place	integer
	Number with decimal place	numeric
	Text	text
	Boolean data	boolean

### 3.4 Optional Elements

Optional elements are denoted with a “true” in the “Opt” column in section 3.5. When a value is not set for an optional element, the element can be omitted from the payload. A designation of “sf” means that the element may be omitted for semifinished lenses (e.g., “Sphere” is not applicable to a semifinished lens blank).

### 3.5 Node Elements Definitions and Requirements

#### 3.5.1 Common Elements

The following elements are present in all nodes, and are not a node in and of themselves.

Field	Description	Literals	Data Type	Opt
OwnerID	This node’s owner	See 5.2	Literal	
Version	This node’s version		Integer	
VersionDate	The date this version was released (ISO-8601 Format)		ISODATE	

#### 3.5.2 LPDSData

The LPDSData element is the top-level element in the catalog, and holds all elements referenced in the catalog.

Field	Description	Literals	Data Type	Opt
BaseCurveCharts	Contains all Base Curve Charts defined in the catalog		{BaseCurveChart}	
BlankCollections	Contains all Blank Collections defined in the catalog		{BlankCollection}	
Blanks	Contains all Blanks defined in the catalog		{Blank}	
CreationDate	The creation date of the catalog		ISODATE	

Description	Description of the catalog, regarding contents and reason for creation		String	
Designs	Contains all Designs defined in the catalog		{Design}	
Layouts	Contains all Layouts defined in the catalog		{Layout}	
MaterialRanges	Contains all Material Ranges defined in the catalog		{MaterialRange}	
Materials	Contains all Materials defined in the catalog		{Material}	
Owners	Contains all Owners defined in the catalog		{Owner}	
ParameterCollections	Contains all Parameter Collections defined in the catalog		{ParameterCollection}	
Parameters	Contains all Parameters defined in the catalog		{Parameter}	
ProductCollections	Contains all Product Collections defined in the catalog		{ProductCollection}	
Products	Contains all Products defined in the catalog		{Product}	
SagCharts	Contains all Sag Charts defined in the catalog		{SagChart}	
Treatments	Contains all Treatments defined in the catalog		{Treatment}	

### 3.5.3 Product

Field	Description	Literals	Data Type	Opt
AvailableMaterials	A collection of available material objects for this product		{AvailableMaterial*}	
AvailableTreatments*	A collection of available treatment objects which can optionally be applied to this product		{AvailableTreatment}	
BaseCurveChartID*	Reference to the base curve chart for this product combination, either at the material level of the treatment level. When this is provided at the material level this		GUID	

	chart is a general use chart and if it is also specified for a material & treatment combination then the latter should be used.			
BlankCollectionIDs $\pm$	Reference to the available treatment's blank collection Identifiers		[BlankCollectionID]	true
DesignID	Reference to the design for this product.		GUID	
Discontinued	Is this product discontinued		Boolean	true
Discontinue Date	Date on which the product was or will be discontinued		ISODATE	true
ExcludedTreatmentIDs $\pm$	Excluded Treatments should not be applied to this product		[TreatmentID]	true
ID	This product's unique Identifier		GUID	
InherentTreatmentIDs $\pm$	<p>Inherent treatments are those which already exist in this product combination.</p> <p>The presence of InherentTreatmentIDs should indicate a treatment that is not present in one or more of the used BlankCollections in the product.</p> <p>An example of such a treatment would be a lab that creates a product from both coated and uncoated blanks, and must apply a coating to the uncoated blanks to create the final product.</p>		[TreatmentID]	true
MaterialID*	Reference to the material for this product combination. Required if MaterialRangeID is not specified.		GUID	
MaterialRangeID*	Reference to the material range for this product combination. Required if MaterialID is not specified.		GUID	
Name	This product's name		String	
RequiredTreatmentIDs $\pm$	Required Treatments must be applied to this product to conform with manufacturers requirements		[TreatmentID]	true



RequiredTreatmentTypes ‡	Required treatment types for the available treatment (generally for unknown blanks) (e.g. "HC")	See 5.5	[Type]	true
--------------------------	---	---------	--------	------

\* denotes child elements of the AvailableMaterials collection

‡ denotes child elements of the AvailableTreatments collection

### 3.5.4 Product Collection

Field	Description	Literals	Data Type	Opt
DiscontinueDate	Date when the collection becomes discontinued		ISODATE	true
EffectiveDate	Date when the collection becomes effective		ISODATE	true
ID	This product collection's unique Identifier		GUID	
Name	This product collection's name		String	
ProductIDs	Reference to products included in this collection.		[ProductID]	

### 3.5.5 Design

Field	Description	Literals	Data Type	Opt
ID	This design's unique Identifier		GUID	
LayoutID	A reference to this design's layout Identifier		GUID	
LDLBL	This design's Lens Design Label (e.g. "Lens Designer")		DCS.String	true
LDVEN	This design's Lens Design Vendor (e.g. "ABC")		DCS.String	
LTYPE	This design's Lens Type (e.g. "PR")		DCS.String	
LTYPEB	This design's Lens Type Back - separated by spaces as specified in the DCS (e.g. "PR FF")		DCS.String	
LTYPEF	This blank collection's Lens Type Front (e.g. "FF"), and dictates the donor lens used in the event the product is a freeform design.		DCS.String	

MandatoryParameterCollectionIDs	A collection of mandatory parameter collection Identifiers which must be supplied when ordering the product.		[ParameterID]	true
MandatoryParameterIDs	Mandatory parameters which must be supplied when ordering the product		[ParameterID]	true
Name	This design's name (e.g. "Progressive Polarized")		String	
OptionalParameterIDs	Optional parameters can be supplied but are not required		[ParameterID]	true
SagChartID	A reference to this design's aspheric surface chart		GUID	true

### 3.5.6 Parameter

Field	Description	Literals	Data Type	Opt
Chiral	Available when using non-standard DCS records. This parameter represents chiral data.		Boolean	
DCSRecordLabel	The record label to use when returning this parameter to a consumer of the DCS format (e.g. "SPH")		String	
Default	This parameter's default Value (e.g. "NA")	["NA"]	Numeric Integer String	± true
Description	This parameter's description (e.g. "Sphere")		String	
ID	This parameter's unique Identifier		GUID	
Max	This parameter's maximum value (e.g. 6)		Numeric Integer	± true
Min	This parameter's minimum value (e.g. -6)		Numeric Integer ±	± true
Name	This parameter's name (e.g. "Sphere")		String	
Type	Available when using non-standard DCS records.	DCS DT	String	true

	This parameter's expected value type (e.g. "numeric")			
--	---	--	--	--

### 3.5.7 Parameter Collection

Field	Description	Literals	Data Type	Opt
ID	This parameter collection's unique Identifier		GUID	
ParameterIDs	Reference to this parameter collection's parameter Identifiers	UID	[ParameterID]	

### 3.5.8 Material Range

Field	Description	Literals	Data Type	Opt
ID	This material range's unique Identifier		GUID	
MaxIndex	The maximum index to which this material range applies		Numeric	
MinIndex	The minimum index to which this material range applies		Numeric	

### 3.5.9 Material

Field	Description	Literals	Data Type	Opt
ABBE	This material's ABBE value (e.g. 58)		Integer	?
Brand	This material's brand (e.g. "Polymer Brand")		String	true
Category	The material category	See 5.4	String	
Density	This material's density (e.g. 1.32)		Numeric	true
dIndex	This material's refractive index - Helium (e.g. 1.499)		Numeric	?
eIndex	This material's refractive index - Mercury (e.g. 1.500)		Numeric	?
ID	This material's unique Identifier		GUID	
LMATNAME	This material's type code (e.g. "PLM")		String	true
Name	This material's name (e.g. "Polymer")		String	true

### 3.5.10 Blank Collection

Field	Description	Literals	Data Type	Opt
BlankIDs	Reference to this blank collection's blank Identifiers		[BlankID]	
Class	The lens blank class	See 5.3	String	
DesignID	This blank collection's design Identifier (for inherent designs).		GUID	
ID	This blank collection's unique Identifier		GUID	
InherentTreatmentIDs	References to this blank collection's inherent treatment Identifiers		[TreatmentID]	
MaterialID	Reference to this blank collection's material Identifier		GUID	
Name	This blank collection's name (e.g. "SF FF Polymer 1.5 (HC)")		String	
RequiredTreatmentTypes	This blank collection's required treatment types (e.g. "HC")	See 5.5	[TreatmentType]	

### 3.5.11 Layout

Field	Description	Literals	Data Type	Opt
BCERIN	Horizontal Distance from blank centre to ERP (e.g. 0)		DCS.Numeric ±	
BCERUP	Vertical Distance from blank centre to ERP (e.g. 0)		DCS.Numeric ±	
BCSGIN	Blank Geometrical Centre (GC) to LRP (e.g. 0)		DCS.Numeric ±	
BCSGUP	LRP location to GC (e.g. 0)		DCS.Numeric ±	
ERDRIN	ERP to Distance Reference Point (DRP) (e.g. 0)		DCS.Numeric ±	
ERDRUP	DRP location to ERP (e.g. 8)		DCS.Numeric ±	
ERNRIN	Engraving Reference Point (ERP) to Near Reference Point (NRP) + means NRP is towards nasal relative to the ERP - means NRP is towards temporal relative to the ERP		DCS.Numeric ±	

ERNRUP	Engraving Reference Point (ERP) to Near Reference Point (NRP) +UP means NRP is above the ERP - UP means NRP is below the ERP		DCS.Numeric ±	
ERSGIN	ERP to Layout Reference Point (LRP) (e.g. 0)		DCS.Numeric ±	
ERSGUP	LRP location to ERP (e.g. 4)		DCS.Numeric ±	
ID	This layout's unique Identifier		GUID	
IntermediateHt	Height of Trifocal Intermediate		DCS.Numeric	true
MFH	Minimum Fitting Height (e.g. 14)		DCS.Numeric	true
Name	This layout's name (e.g. "Curve Top Bifocal")		String	true
SDEPTH	Segment Depth (e.g. 0)		DCS.Numeric	true
SEGSEP	Segment separation		DCS.Numeric	true
SGOCIN	LRP to Prism Reference Point (PRP) (e.g. 0)		DCS.Numeric ±	
SGOCUP	PRP location to LRP (e.g. 0)		DCS.Numeric ±	
SMDMAX	Maximum Decentration (in, out, up, down) (e.g. "15;15;15;15")		DCS.String	true
SWIDTH	Segment Width (e.g. 0)		DCS.Numeric	true

### 3.5.12 Treatment

Field	Description	Literals	Data Type	Opt
Brand	This treatment's brand name (e.g. "Example Brand Name")		String	true
DCSFields	This treatment's type DCS object collection.		{DCSField}	true
ID	This treatment's unique Identifier		GUID	
Name	This treatment's name (e.g. "Hardcoat")		String	
Types	A collection of literals as defined in section 5.5, with each having the element name of "Type"	See 5.5	[Type]	

## 3.5.13 Blank

Field	Description	Literals	Data Type	Opt
ADD	This blank's add power (e.g. 2.00)		DCS.Numeric ±	true
ADDU	This blank's upper add power		DCS.Numeric ±	true
BACKR	This blank's back radius (e.g. 82.75)		DCS.Numeric	
BCTHK	This blank's Centre Thickness (e.g. 10.6)		DCS.Numeric	
BETHK	This blank's Edge Thickness (e.g. 7.5). In the event of conflict in calculated thickness as compared with the BCTHK and curve values, the value in BCTHK overrides.		DCS.Numeric	
CCBOWL	Bowl diameter (optical zone) on a lenticulated back surface		DCS.Numeric	true
CCCARR	Spherical carrier curve on a lenticulated back surface		DCS.Numeric	true
CXBOWL	Bowl diameter (optical zone) on a lenticulated frontside surface.		DCS.Numeric	true
CXCARR	Spherical carrier curve on a lenticulated frontside surface.		DCS.Numeric	true
CYL	This finished blank's cyl power (e.g. -.75)		DCS.Numeric ±	sf
DIA	This blank's maximum diameter (e.g. 70)		DCS.Integer	
FRNTR	This blank's front radius (e.g. 175.58)		DCS.Numeric	
ID	This blank's unique Identifier		GUID	
LayoutID	Reference to this blank's relevant layout		GUID	true
LeftID	This blank's left Identifier (when OPC not used)		String	true
LeftOPC	This blank's left Optical Product Code		String	true
LSIZ	This blank's nominal diameter (e.g. 70)		DCS.Numeric	
MBASE	This blank's marked base (e.g. 8.00)		DCS.Numeric	
PLRCRVR	This blank's Polarizing or Other Film Curvature radius		Numeric	true

PLRLOC	This blank's Polarizing or Other Film Location behind front surface (mm) (e.g. 0.50)		DCS.Numeric	true
ReferenceID	Unique product identifier		String	true
RightID	This blank's right identifier (when OPC not used)		String	true
RightOPC	This blank's right Optical Product Code		String	true
SEGTHK	Fused glass segment thickness		Numeric	true
SLBP	Slaboff prism diopters. (LIND or "natural" diopters)		DCS.Numeric	true
SPH	This finished blank's sphere power (e.g. 7.0)		DCS.Numeric	sf
UsableHorizontalDiameter	This blank's usable horizontal diameter (e.g. 69)		Integer	true
UsableVerticalDiameter	This blank's usable vertical diameter (e.g. 69)		Integer	true

### 3.5.14 Owner

Field	Description	Literals	Data Type	Opt
Address	The contact's address		String	true
ContactName	The contact's name		String	true
Email	The contact's email		String	true
ID	This owner's unique Identifier from section 5.2.		String	
Name	This owner's name (e.g. "Vision Company")		String	
Phone	The contact's phone		String	true
URL	The contact's web address		String	true

### 3.5.15 Base Curve Chart

Please see section 6 for further description of the base curve chart format contained in the Standard

Field	Description	Literals	Data Type	Opt
Adds	This base curve chart's add power range collection containing a set of		{Add}	

	objects, each one having a MinAdd, a MaxAdd, and a Lines object.			
ID	This base curve chart's unique identifier		GUID	
Lines	This base curve chart's add power definitions (e.g. "350","325", etc) with Condensed Base Chart Ranges (e.g. "-950,-262,null")	CBCR	[Line]	
MaxAdd	The maximum add power for which these base curve chart lines apply		Numeric	
MinAdd	The minimum add power for which these base curve chart lines apply		Numeric	

### 3.5.16 Sag Chart

Please see section 7 for further description of the sag chart format contained in the Standard

Field	Description	Literals	Data Type	Opt
ID	This sag chart's unique identifier		GUID	
Lines	This sag chart's record definitions as shown in section 7		['Line' elements]	

### 3.5.17 DCSField

Field	Description	Literals	Data Type	Opt
Tag	The DCS tag		String	
Value	The value assigned to this tag		String	

## 3.6 Guidelines for specifying geometrical (physical) measurements of lens blanks

The physical specifications for the geometry of lens blanks, the geometry of lens blanks, and the location of multifocals segments within the lens shall be provided using the methods and conventions described below. Numeric values and text should adhere to the sign convention developed in Section 2.2. All physical distances shall be expressed in millimeters (mm). For "Plano" surfaces with zero curvature, which have an infinitely long radius of curvature, the radius shall be expressed as zero (0).

### 3.6.1 Specifying surface power by radius

#### 3.6.1.1 Front curve surface power (Frnt Rad)



The front curve surface power, which is the value used for surfacing power calculations, shall be specified using the instantaneous radius of curvature of the front surface at the distance reference point (DRP) of the lens blank. This has been illustrated in Figure 1. Note that convex front curves have a positive radius while concave front curves have a negative radius.

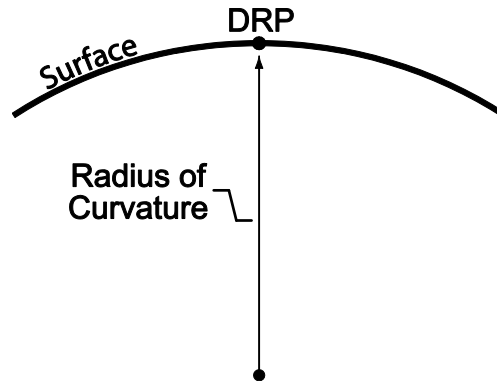

**Figure 1** Instantaneous radius of curvature

#### 3.6.1.2 Back curve surface power (Bck Rad)

The back curve surface power shall be specified using the radius of curvature of the rear surface at either the distance reference point (DRP) or the geometric center of the lens blank. Note that concave back curves have a positive radius while convex back curves have a negative radius. This value is recommended but not required for finished lens blanks. When this value is supplied for finished lens blanks with cylinder power, the radius of curvature provided shall be that through the principal meridian of the lens containing the specified sphere power (Sph).

#### 3.6.1.3 Lenticular curve surface power (Car Rad)

The lenticular curve surface power shall be specified using the radius of curvature of the front lenticular surface within the carrier zone of the lens blank.

### 3.6.2 Specifying lens blank center thickness (C Thk)

The center thickness of the lens blank shall be specified as the thickness of the blank at its geometric center, measured normal (perpendicular) to the front and back surfaces. This measurement has been illustrated in Figure 2. The *mean* (or average) center thickness shall be provided from a statistically-significant sample population of the lens blanks. This value is *not* required for *finished* lens blanks whose nominal edge thickness is less than the center thickness (e.g., plus-powered lenses).

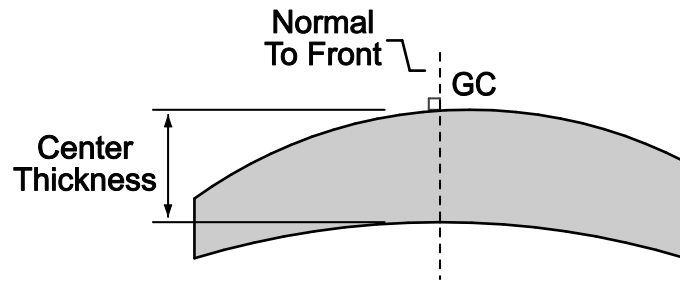

**Figure 2** Center thickness of a (progressive) lens blank

### 3.6.3 Specifying lens blank edge thickness (E Thk)

The edge thickness of semi-finished lens blanks shall be specified as the thickness of the blank at its uppermost vertical ( $90^\circ$ ) edge, measured parallel to an imaginary axis passing through the geometric center of the lens blank and normal to the front surface. This measurement has been illustrated in Figure 3. The mean (or average) edge thickness shall be provided from a statistically-significant sample population of the lens blanks. This value is recommended but not required for finished lens blanks. When this value is supplied for finished lens blanks, the edge thickness provided shall be that at the meridian of the lens containing the sphere power.

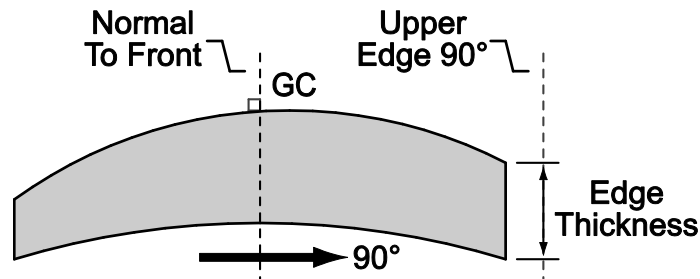

**Figure 3** Edge thickness of a (progressive) lens blank

### 3.6.4 Specifying layout reference point location (LRP In and LRP Down)

The location of the *layout reference point* (LRP), which includes the segment of conventional multifocal lenses and the fitting cross of progressive addition lenses, shall be specified relative to the *geometric center* (GC) of the lens blank, using the sign convention described in Section 2.2.

For flat-top, curve-top, Executive-style, and similar multifocal lenses, **LRP In** shall be specified as the horizontal location and **LRP Down** shall be specified as the vertical location of the segment, relative to the geometric center of the lens blank. *LRP In* represents the horizontal separation, as measured parallel to the uppermost edge (or border) of the segment, between the geometric center of the lens blank and a vertical axis that bisects the segment. *LRP Down* refers to the vertical separation, as measured parallel to a vertical axis that bisects the segment, between the geometric center of the lens blank and a horizontal line that is tangent to the uppermost edge (or border) of the segment. These measurements have been illustrated in Figure 4.

For single vision lenses, the *LRP In* and *LRP Down* shall be assumed to be coincident with the geometric center of the lens blank, unless otherwise specified (e.g., for decentered single vision aspheric lenses).

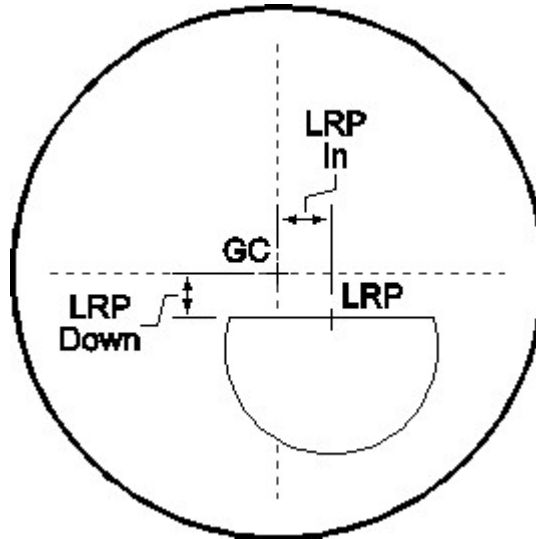

**Figure 4** Layout reference point location of a lined multifocal lens blank

For progressive lenses, *LRP In* shall be specified as the horizontal location and *LRP Down* shall be specified as the vertical location of the fitting cross, relative to the geometric center of the lens blank. Since the fitting cross of most progressive addition lenses is located *above* the geometric center, the *LRP Down* value for such lenses will typically be *negative* (-). These measurements have been illustrated in Figure 5 for a decentered lens blank.

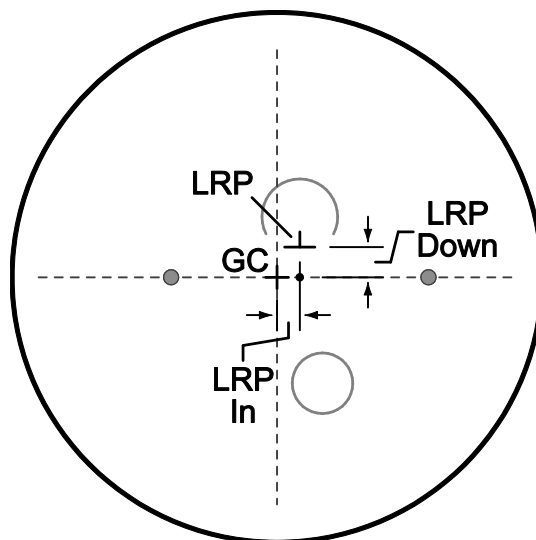

**Figure 5** Layout reference point location of a progressive addition lens blank

For round and blended multifocal lenses, *LRP Down* shall be specified as the vertical location of the segment, relative to the geometric center of the lens blank. For such lenses, **LRP Down** is the minimum separation (or the shortest distance) between the geometric center of the lens blank the uppermost edge of the segment boundary or ink markings (if blended). An

*LRP In* measurement is not necessary, since these lenses require no initial horizontal orientation. The *LRP Down* measurements are illustrated in Figure 6.

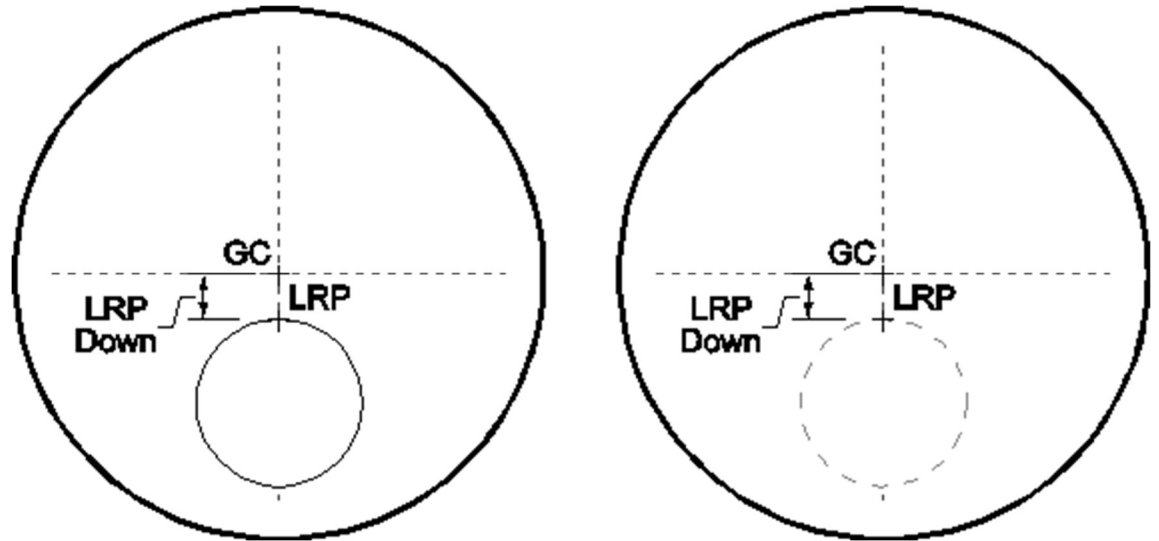

**Figure 6** Layout reference point location of round and blended multifocal lens blanks

### 3.6.5 Specifying prism reference point location (*PRP Out* and *PRP Up*)

The location of the *prism reference point* (*PRP*) shall be specified relative to the *layout reference point* (*LRP*) of the lens blank using the sign convention described in Section 2.2.

**PRP Out** shall be specified as the horizontal location and **PRP Up** shall be specified as the vertical location of the prism reference point, relative to the layout reference point of the lens blank. *PRP Out* represents the horizontal separation, as measured parallel to a horizontal axis that intersects the prism reference point, between the layout reference point of the lens blank and a vertical axis that intersects the prism reference point. *PRP Up* refers to the vertical separation, as measured parallel to a vertical axis that intersects the prism reference point, between the layout reference point of the lens blank and a horizontal axis that intersects the prism reference point.

Although spherical, semi-finished single vision and multifocal lenses will typically not have a prism reference point specified by the manufacturer, progressive, aspheric, and finished multifocal lenses generally should have a *PRP* location specified. When no separate prism reference point is specified, it shall be assumed to coincide with the layout reference point of the lens blank. The prism reference point location of a progressive lens blank is illustrated in Figure 7.

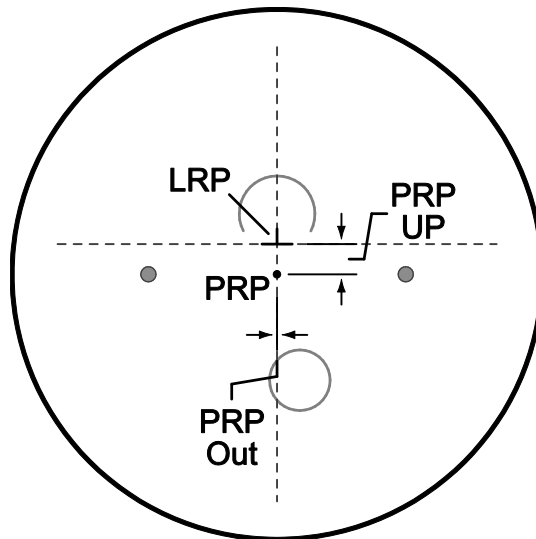

**Figure 7** Prism reference point location of a progressive lens blank

### 3.6.6 Specifying distance and near reference point locations (DRP In, DRP Up, NRP In, and NRP Up)

The location of the *distance reference point* (DRP) and *near reference point* (NRP) shall be specified relative to the *prism reference point* (PRP) of the lens blank using the sign convention described in Section 2.2.

**DRP In** shall be specified as the horizontal location and **DRP Up** shall be specified as the vertical location of the distance reference point, relative to the prism reference point of the lens blank. *DRP In* represents the horizontal separation, as measured parallel to a horizontal axis that intersects the distance reference point, between the prism reference point of the lens blank and a vertical axis that intersects the distance reference point. *DRP Up* refers to the vertical separation, as measured parallel to a vertical axis that intersects the distance reference point, between the prism reference point of the lens blank and a horizontal axis that intersects the distance reference point.

**NRP In** shall be specified as the horizontal location and **NRP Up** shall be specified as the vertical location of the near reference point, relative to the prism reference point of the lens blank. *NRP In* represents the horizontal separation, as measured parallel to a horizontal axis that intersects the near reference point, between the prism reference point of the lens blank and a vertical axis that intersects the near reference point. *NRP Up* refers to the vertical separation, as measured parallel to a vertical axis that intersects the near reference point, between the prism reference point of the lens blank and a horizontal axis that intersects the near reference point.

Although single vision and multifocal lenses will frequently not have distance or near reference points specified by the manufacturer, general-purpose progressive lenses shall have both DRP and NRP locations specified. For certain task-specific progressive lenses, however, separate DRP and NRP locations may not exist. The distance and near reference

point locations of a general-purpose progressive lens blank are illustrated in Figure 8.

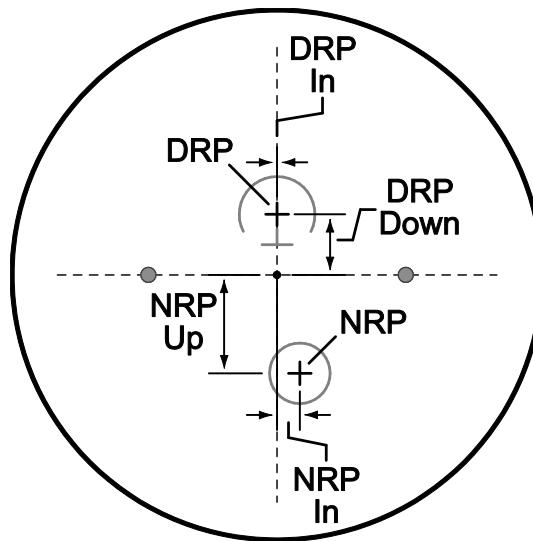

**Figure 8** Distance and near reference point locations of a progressive lens blank

### 3.6.7 Specifying bowl diameter (Bwl Diam)

The **bowl diameter** of a lenticulated lens blank (for example, a 40-mm post-cataract lens) shall be specified as the widest horizontal dimension of the bowl, which is the central optically-usable zone. This is the horizontal distance between two parallel lines tangent to the right and left outermost edges of the bowl. This is illustrated in Figure 9.

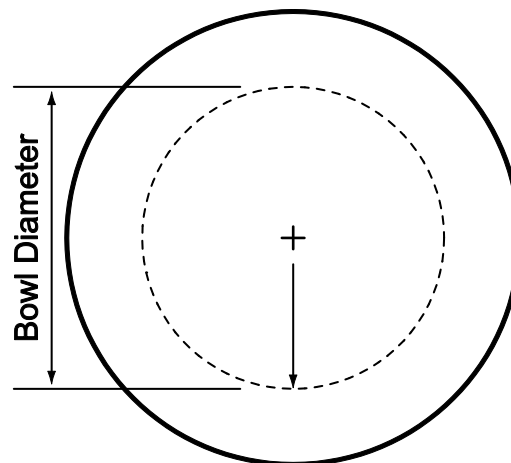
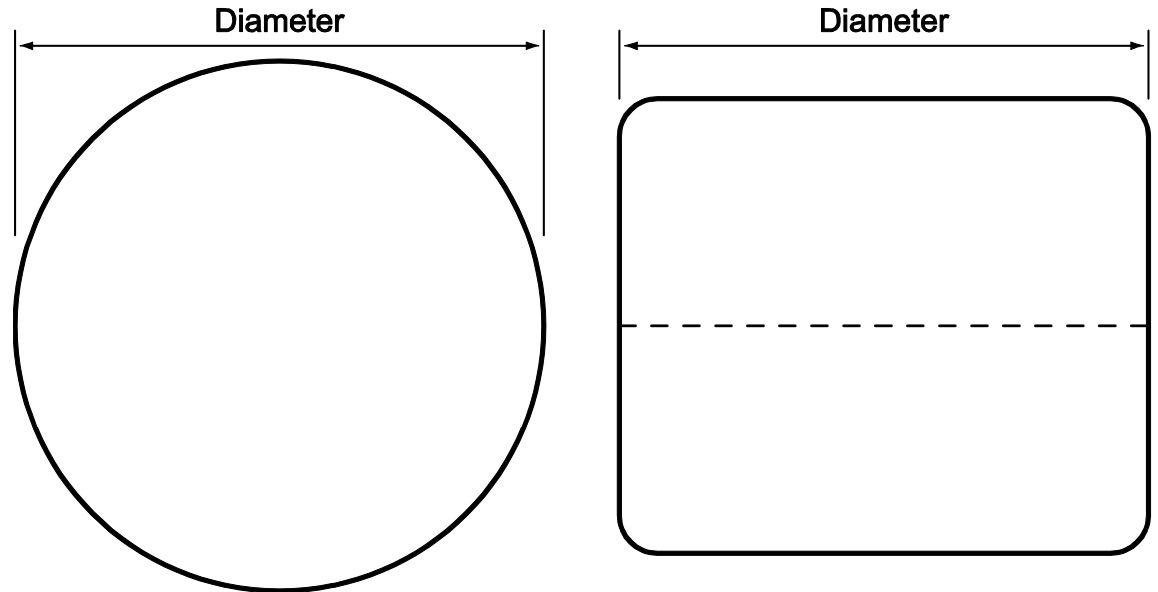

**Figure 9** Specifying the bowl diameter of a lenticulated lens blank

### 3.6.8 Specifying blank diameter (Diameter, Ver Diam, Hor Diam, and Nom Diam)

The **diameter** of the lens blank shall be specified as the widest horizontal dimension of the blank. This is the horizontal distance between two parallel lines tangent to the right and left outermost edges of the lens blank, regardless of the presence of any encroachments or other physical limitations. This is illustrated in Figure 10, for two different lens blank shapes.

Additionally, a **marked** or **nominal diameter** (Nom Diam) field is available in order to allow the lens manufacturer to specify a value that does not necessarily comply with the physical definition of the Diameter field, provided above. For example, the nominal diameter (Nom Diam) provided on the lens packaging label or used to identify the lens blank in an order entry system may differ from the physical diameter (Diameter).



**Figure 10** Specifying the *diameter* of a lens blank

For lens blanks with a vertical dimension that differs from the horizontal dimension or lens blanks with physical encroachments that limit the usable size of the lens blank in one or more dimensions, including lenticular lips for progressive lenses and horizontal alignment marks for polarized lenses, additional measurements can be provided. Additionally, the type of encroachment should be identified using the appropriate literal in the **Special** field. For lens blanks with physical encroachments in the horizontal meridian, the **horizontal diameter** (Hor Diam) shall be specified as the twice the shortest distance from the geometric center (GC) of the lens blank to any physical encroachment that obstruct the optical use of the lens blank along a horizontal (180°) axis containing the geometric center. These diameter measurements are illustrated in Figure 11. When no encroachments are present, this measurement is equal to the diameter measurement and is therefore not required.

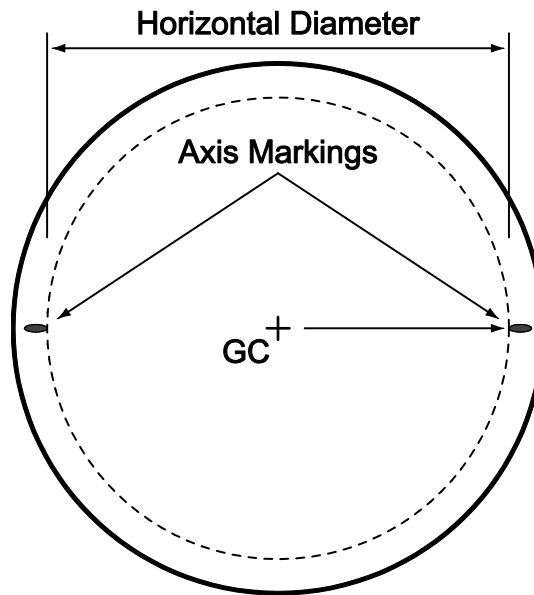

**Figure 11** Specifying the *horizontal* diameter of a lens blank

For lens blanks with a vertical dimension that differs from the horizontal dimension, the **vertical diameter** (Ver Diam) shall be specified as the tallest vertical dimension of the lens blank. For lens blanks with physical encroachments in the vertical meridian, the **vertical diameter** (Ver Diam) shall be specified as the twice the shortest distance from the geometric center (GC) of the lens blank to any physical encroachment that obstructs the optical use of the lens blank along a vertical ( $90^\circ$ ) axis containing the geometric center. These diameter measurements are illustrated in Figure 12.

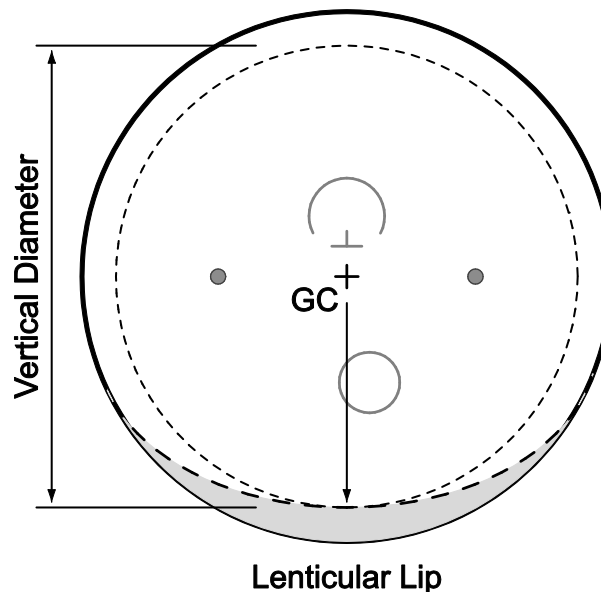

**Figure 12** Specifying the *vertical* diameter of a lens blank

### 3.6.9 Specifying segment geometry

#### 3.6.9.1 Lined multifocal segment width (Seg Wd)



The width of lined multifocal segments, with the exception of full-width or Executive-style lenses, shall be specified as the widest horizontal dimension of the segment. This is the horizontal distance between two parallel lines tangent to the right and left outermost edges of the segment boundary or ink markings (if blended), as illustrated in Figure 13.

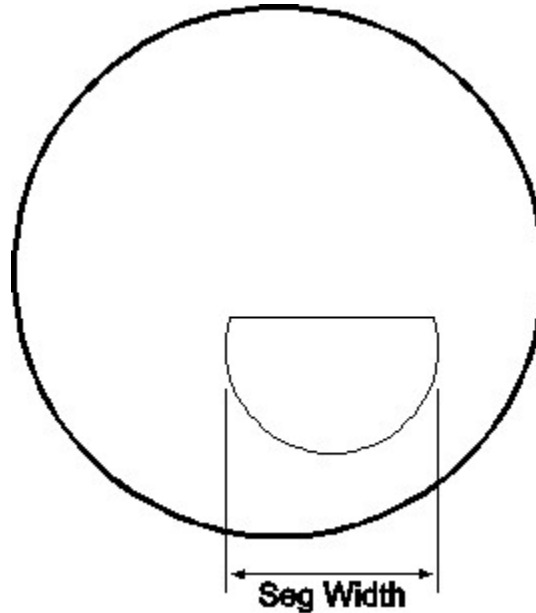

**Figure 13** Specifying the segment width of a lined (flat-top) multifocal

#### 3.6.9.2 Lined trifocal intermediate height (Int Ht)

The intermediate height of lined trifocal segments shall be specified as the minimum vertical separation between a line tangent to the uppermost edge (or border) of the bifocal segment and a horizontal line tangent to the uppermost edge (or border) of the trifocal segment, as illustrated in Figure 14.

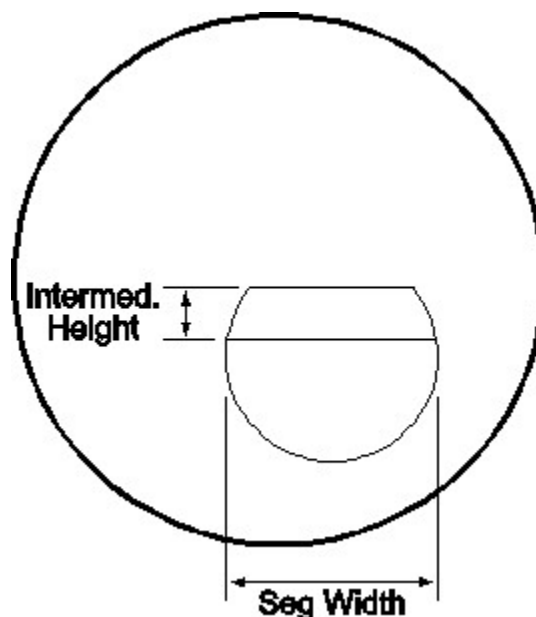

**Figure 14** Intermediate height of a lined (flat-top) trifocal lens

## 3.6.9.3 Fused glass segment thickness (Seg Thk)

The segment thickness of fused glass multifocal lenses shall be specified as the thickness of the segment button at the optical center of the segment. (Note that this is not the resultant optical center of the combined segment and distance portion.)

## 3.6.10 Specifying the geometry an imbedded object (Obj Clear and Obj Rad)

For semi-finished lens blanks that have a polarized film, laminate layer, or other *imbedded object* within the lens blank that must be avoided during the lens surfacing process, dimensions may be specified to characterize the three-dimensional region of the lens blank that should be excluded from lens surfacing, relative to the front surface.

The **object clearance** shall be specified as the minimum distance to use for lens surfacing calculations from the front surface of the lens blank along an axis perpendicular to the front surface at the geometric center (GC) of the lens blank. Unless otherwise specified, the object clearance represents a uniform distance from the front surface over the entire lens blank, so that the rear boundary of the imbedded object region is nominally equally to the front surface curve of the lens blank, as illustrated in Figure 15.

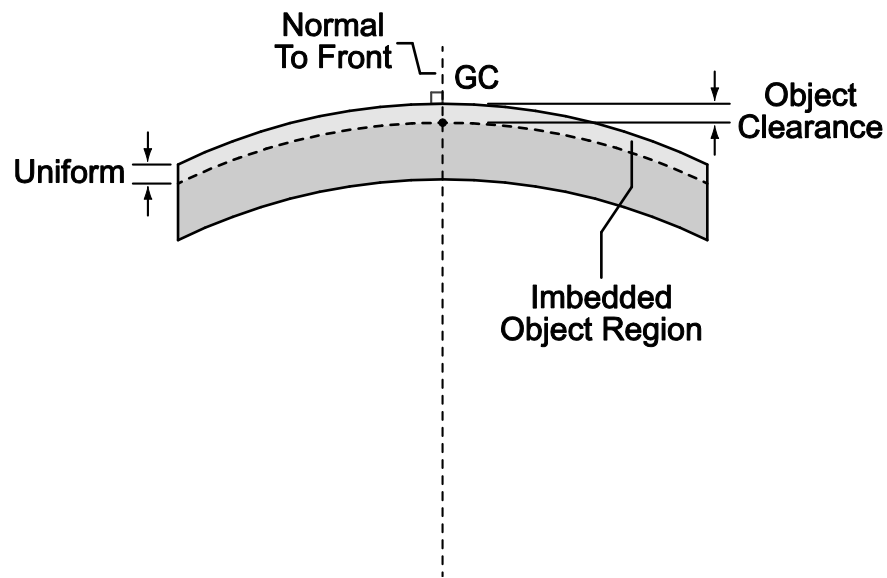
**Figure 15** Specifying the uniform *clearance* of an object imbedded within the lens blank

Additionally, an optional parameter may be specified that defines the rear curve of the imbedded object region, when a uniform clearance from the front surface will not suffice. The **object radius** shall be specified as the radius of the spherical curve that bounds the three-dimensional region to exclude from lens surfacing as measured from the object clearance distance along an axis perpendicular to the front surface at the geometric center. For imbedded objects with known curvature, such as a film or layer that follows the nominal shape of the front surface of the lens blank, the

object radius may be defined by this curvature as illustrated in Figure 16. If an object radius is not specified, the object clearance distance shall be assumed to be uniform (equidistant from the front surface) over the lens blank.

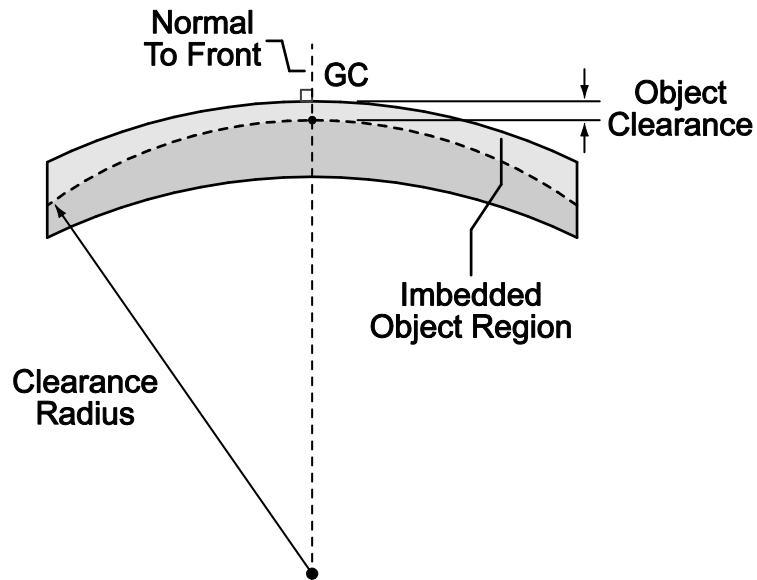

**Figure 16** Specifying the *radius* of an object imbedded within the lens blank

## 4 Standard File Format Examples

The examples below should serve as paradigms for creating and disseminating the lens specification and surface description files described in this Standard.

### 4.1 Example XML File

```
<?xml version="1.0" encoding="utf-16"?>
<LPDSData xmlns:xsi="http://www.w3.org/2001/XMLSchema-instance"
xmlns:xsd="http://www.w3.org/2001/XMLSchema">
  <Products>
    <Product>
      <OwnerID>TVC</OwnerID>
      <ProductName>Example Product</ProductName>
      <ID>12a6bf4d-9c9e-4ecc-a09d-3a4487138608</ID>
      <DesignID>f220ae3f-d1d5-4ca4-a8e9-4479a23501e4</DesignID>
      <AvailableMaterials>
        <AvailableMaterial>
          <MaterialRangeID>7bcde269-e47b-48ab-8c6f-
7a29e36c8fa6</MaterialRangeID>
          <BaseCurveChartID>46c4227b-eb26-44da-a785-
4a2d2fc296</BaseCurveChartID>
        </AvailableMaterial>
        <AvailableMaterial>
          <MaterialID>cd27491b-14df-4c9b-94aa-
d9050eba53c0</MaterialID>
          <BaseCurveChartID>46c4227b-eb26-44da-a785-
4a2d2fc296</BaseCurveChartID>
        <AvailableTreatments>
          <AvailableTreatment>
            <InherentTreatmentIDs>
              <ID>c294b8ba-68b6-4805-84f3-1df454d28528</ID>
            </InherentTreatmentIDs>
            <RequiredTreatmentIDs />
            <ExcludedTreatmentIDs />
            <BaseCurveChartID>46c4227b-eb26-44da-a785-
4a2d2fc296</BaseCurveChartID>
            <BlankCollectionIDs>
              <ID>147a3713-82ca-4881-bc08-ab2f51e26d8b</ID>
            </BlankCollectionIDs>
            <MandatoryParameterIDs>
              <ID>14f43d64-e555-4ee9-935b-c74cf22bf76b</ID>
              <ID>1a9311b0-165a-42ca-af5c-5d55bb8580c6</ID>
            </MandatoryParameterIDs>
            <RequiredTreatmentTypes />
          </AvailableTreatment>
        </AvailableTreatments>
      </AvailableMaterials>
    </Product>
  </Products>
</LPDSData>
```

```

        </AvailableMaterial>
    </AvailableMaterials>
</Product>
</Products>
<Designs>
  <Design>
    <ID>f220ae3f-d1d5-4ca4-a8e9-4479a23501e4</ID>
    <OwnerID>TVC</OwnerID>
    <Description>Example Design</Description>
    <LDVEN>VEN</LDVEN>
    <LDLBL>Example</LDLBL>
    <LTYPE>PR</LTYPE>
    <LTYPEB>PR FF</LTYPEB>
    <LTYPEF>SV</LTYPEF>
    <IsFreeform>true</IsFreeform>
    <LayoutID>d0aa888b-c365-442d-8946-845e52a656b5</LayoutID>
    <MandatoryParameterCollectionIDs>
      <ID>54f43d64-e575-42e9-9e5b-a7ecf22bf76g</ID>
    </MandatoryParameterCollectionIDs>
    <MandatoryParameterIDs />
    <OptionalParameterIDs />
  </Design>
</Designs>
<Parameters>
  <Parameter>
    <ID>14f43d64-e555-4ee9-935b-c74cf22bf76b</ID>
    <OwnerID>TVC</OwnerID>
    <Name>Sphere</Name>
    <Description>Sphere</Description>
    <DCS>SPH</DCS>
    <Type>Numeric</Type>
    <Min>-6</Min>
    <Max>6</Max>
    <Default>NA</Default>
  </Parameter>
</Parameters>
<ParameterCollections>
  <ParameterCollection>
    <OwnerID>TVC</OwnerID>
    <ID>54f43d64-e575-42e9-9e5b-a7ecf22bf76g</ID>
    <ParameterIDs>
      <ID>14f43d64-e555-4ee9-935b-c74cf22bf76b</ID>
      <ID>1a9311b0-165a-42ca-af5c-5d55bb8580c6</ID>
    </ParameterIDs>
  </ParameterCollection>
</ParameterCollections>

```

```

<MaterialRanges>
  <MaterialRange>
    <OwnerID>TVC</OwnerID>
    <ID>7bcde269-e47b-48ab-8c6f-7a29e36c8fa6</ID>
    <MinIndex>1.499</MinIndex>
    <MaxIndex>1.52</MaxIndex>
  </MaterialRange>
</MaterialRanges>
<Materials>
  <Material>
    <ID>cd27491b-14df-4c9b-94aa-d9050eba53c0</ID>
    <OwnerID>TVC</OwnerID>
    <Brand>Example Polymer Brand</Brand>
    <Category>PM</Category>
    <LMATNAME>PM</LMATNAME>
    <Description>Polymer</Description>
    <dIndex>1.499</dIndex>
    <eIndex>1.5</eIndex>
    <dABBE>58</dABBE>
    <eABBE>56</eABBE>
    <Density>1.32</Density>
  </Material>
</Materials>
<BlankCollections>
  <BlankCollection>
    <OwnerID>TVC</OwnerID>
    <ID>147a3713-82ca-4881-bc08-ab2f51e26d8b</ID>
    <MaterialID>cd27491b-14df-4c9b-94aa-
d9050eba53c0</MaterialID>
    <DesignID>f220ae3f-d1d5-4ca4-a8e9-4479a23501e4</DesignID>
    <BlankIDs>
      <ID>961b7de8-619a-42e6-8b79-54cf1ed9fcda</ID>
      <ID>a6886d25-7ae2-4c68-9a6b-abc887de1086</ID>
      <ID>2f0bd52b-d1db-436f-8fad-77fba2b4564b</ID>
      <ID>a773eb05-971d-4ad2-b4a6-39cc68935f57</ID>
      <ID>d65884de-0946-4179-b02c-a6bcf152e5a0</ID>
      <ID>0168c279-f934-4453-8345-834fc0b6afc8</ID>
      <ID>e6e48f07-b29a-4250-97cb-1e7e6023b977</ID>
    </BlankIDs>
    <Description>SF FF Polymer 1.5 - Hard Coated
Pucks</Description >
    <InherentTreatmentIDs>
      <ID>c294b8ba-68b6-4805-84f3-1df454d28528</ID>
    </InherentTreatmentIDs>
    <RequiredTreatmentTypes />
  </BlankCollection>

```

```

</BlankCollections>
<Layouts>
  <Layout>
    <ID>d0aa888b-c365-442d-8946-845e52a656b5</ID>
    <OwnerID>TVC</OwnerID>
    <Name>Example Layout</Name>
    <ERNRIN>0</ERNRIN>
    <ERNRUP>4</ERNRUP>
    <ERSGIN>0</ERSGIN>
    <ERSGUP>4</ERSGUP>
    <ERDRIN>0</ERDRIN>
    <BCERIN>0</BCERIN>
    <ERDRUP>8</ERDRUP>
    <BCERUP>0</BCERUP>
    <BCSGIN>0</BCSGIN>
    <BCSGUP>0</BCSGUP>
    <SWIDTH>0</SWIDTH>
    <SDEPTH>0</SDEPTH>
    <SGOCIN>0</SGOCIN>
    <SGOCUP>0</SGOCUP>
    <SBSGIN>0</SBSGIN>
    <SBSGUP>0</SBSGUP>
    <SMDMAX>15;15;15;15</SMDMAX>
    <MFH>14</MFH>
  </Layout>
</Layouts>
<Treatments>
  <Treatment>
    <ID>c294b8ba-68b6-4805-84f3-1df454d28528</ID>
    <OwnerID>TVC</OwnerID>
    <Type>AR SR</Type>
    <Brand>Example Treatment Brand</Brand>
    <Description>Polarized Coating</Description >
    <Subtype>AR</Subtype>
    <DCSFields>
      <DCSField>
        <tag>POLAR</tag>
        <value>1</value>
      </DCSField>
    </DCSFields>
  </Treatment>
</Treatments>
<Blanks>
  <Blank>
    <ID>961b7de8-619a-42e6-8b79-54cf1ed9fcda</ID>
    <OwnerID>TVC</OwnerID>

```

```

<RightOPC>5115589888</RightOPC>
<LeftOPC>5115589888</LeftOPC>
<BCTHK>10.6</BCTHK>
<BETHK>15.8</BETHK>
<DIA>76</DIA>
<LSIZ>76</LSIZ>
<UsableDiameter>75</UsableDiameter>
<LayoutID>d0aa888b-c365-442d-8946-845e52a656b5</LayoutID>
<PLRCRVR>1317.38</PLRCRVR>
<PLRLOC>0.5</PLRLOC>
<MBASE>0</MBASE>
<ADD>0</ADD>
<FRNTR>175.58</FRNTR>
<BACKR>82.75</BACKR>
</Blank>
</Blanks>
<Owners>
  <Owner>
    <OwnerID>TVC</OwnerID>
    <OwnerName>The Vision Council</OwnerName>
    <Contact>
      <Name>...</Name>
      <Address>...</Address>
      <Phone>...</Phone>
      <Email>...</Email>
      <WebAddress>...</WebAddress>
    </Contact>
  </Owner>
</Owners>
<BaseCurveCharts>
  <BaseCurveChart>
    <ID>46c4227b-eb26-44da-a785-4a2d2fcdc296</ID>
    <OwnerID>TVC</OwnerID>
    <Adds>
      <Add>
        <MinAdd>0</MinAdd>
        <MaxAdd>0</MaxAdd>
        <Lines>
          <Line>-950, -262, null</Line>
          <Line>-950, -75, 50</Line>
          <Line>-950, 0, 130</Line>
          ...etc
        </Lines>
      </Add>
    </Adds>
  </BaseCurveChart>

```



```
</BaseCurveCharts>  
</LPDSData>
```

## 5 Literal Abbreviations

The indices below represent the lists of *literal* abbreviations currently acknowledged by the Vision Council for use in describing the technical and commercial attributes of lenses, as of the version date of this document. These abbreviations are used as literals for the Filter (**Filter**) and Owner fields. To create additional abbreviations (for new products or companies), delete existing abbreviations, or to obtain the most current list of literals, please contact the Vision Council:

Michael Vitale, ABOM  
 The Vision Council  
 225 Reinekers Lane, Suite 700  
 Alexandria, VA 22314  
 (703) 548-2684  
 mvitale@thevisioncouncil.org

### 5.1 Filter Color Abbreviations (Filter)

For absorptive lenses with color, 4-character literals shall be used to identify the color and transmittance properties of the lens within the **Filter** field. The first 3 characters shall indicate the color name and the last character shall be an integer value (*n*) from 0 through 4 describing the transmittance or shade of the lens. This value, which is determined at the manufacturer's discretion, most commonly ranges from 1 to 3—with the lower values representing higher levels of transmittance and vice versa.

Although optional for photochromic lenses, two separate 4-character literals—separated by a space—may be used to identify the color and transmittance of the lens in both the inactivated (faded) and activated (darkened) states. When only a single 4-character literal is supplied, it shall be assumed that this literal identifies the color and transmittance of the lens in the activated (darkened) state and that the lens is clear or nearly so in the inactivated (faded) state.

Color	Literal	Example
Amber	AMB <i>n</i>	AMB2
Amethyst	AMT <i>n</i>	AMT1
Aquamarine	AQU <i>n</i>	AQU2
Autumn Gold	ATG <i>n</i>	ATG3
Blue	BLU <i>n</i>	BLU3
Brown	BRN <i>n</i>	BRN2
Copper	COP <i>n</i>	COP1
Didymium	DID <i>n</i>	DID2
Gold	GLD <i>n</i>	GLD3

Color	Literal	Example
Green	GRN <i>n</i>	GRN1
Green-Gray	G15 <i>n</i>	G153
Gray	GRY <i>n</i>	GRY3
Melanin	MEL <i>n</i>	MEL3
Orange	ORG <i>n</i>	ORG2
Pewter	PEW <i>n</i>	PEW1
Pink	PNK <i>n</i>	PNK2
Purple	PUR <i>n</i>	PUR3
Rainbow	RNB <i>n</i>	RNB2
Red	RED <i>n</i>	RED1
Rose	ROS <i>n</i>	ROS2
Sapphire	SAP <i>n</i>	SAP2
Silver	SIL <i>n</i>	SIL3
Tan	TAN <i>n</i>	TAN3
Therminon	THR <i>n</i>	THR1
Unisol	UNI <i>n</i>	UNI2
Violet	VIO <i>n</i>	VIO2
Yellow	YEL <i>n</i>	YEL0

## 5.2 Owner Abbreviations

To uniquely identify the class owner, a 6-character or fewer literal shall be provided in the owner identifier. *Note: The below list is provided as an example only and is not intended to be a complete list.*

Company Name and Region	Literal
American Optical Corporation	AO
Augen Opticos dba; Blue Cove	AUGEN
Carl Zeiss (Germany)	ZSS
Centennial Optical	CENT
Conant	CONANT
D & D Optical Supply	WX
Essilor France	ESS
Essilor of America	ESS
Eye Solutions Inc	BLUTEC
Eyenvision	EYENV8
GKB Hitech Lenses Pvt Ltd	GKB

<b>Company Name and Region</b>	<b>Literal</b>
Hoya Corp/Hoya Lens of America	HOY
Indizen Optical Technologies	IOT
Indo Lens Group SLU	IND
Intercast Europe SRL	ICG and INT
International Lens Company	INLECO
Kaenon Polarized	KP
Kbco Polarized Lenses	KBC
Landon Lens Manufacturing Corp	LAN
Lehrer Brillen-Perfection Werks (LBI)	LBI
Lensco	LNS
Nassau Lens Company	NAS and NASSAU
Nikon Essilor Co LTD	NIKON
Optima, Inc	OPT
Pentax Vision	PNT
Polycore Optical Pte Ltd	POUSA
Prio Corporation	PRIO
Private Label Optical	PLO
Rodenstock Germany	ROD
Rozin Optical International LLC	ROZIN
Scopus Optical Industry	SCOPUS
Seiko Optical Products	SKO
Shamir Insight Inc.	SHAMIR
Shore Lens	SHORE and SHO
Signet Armorlite	SAUSA and SA
Silor/Essilor	ESS
Sola Optical USA, Inc	SOUSA
Somo Optical	SOMUSA and SOM
Specialty Lens Corp/Essilor	SLC
Techtran Polylenses LTD	TPL
Thai Optical Group Public Co	TOG
Tokai Optical Co Ltd	TOKAI
UVCO (United Vision Corp)	UVCO
Varilux/Essilor	VAR
Vision Dynamics	PT
Vision Warehouse LLC	VW
Vision-Ease Lens	VE
X-Cel Optical	XCL
Younger Optics	YNG

### 5.3 Lens Blank Classes

<b>Lens Class</b>	<b>Literal</b>
Finished	FIN
Finished / Extra Thin	FNT
Semi-Finished	SFN
Semi-Finished / Extra Thick	SFX

### 5.4 Material Categories

<b>Material Category</b>	<b>Literal</b>
Glass	GL
Glass Mid-Index ( $n > 1.53$ )	GM
Glass High-Index ( $n > 1.59$ )	GH
Glass Ultra-Index ( $n > 1.65$ )	GU
Plastic	PL
Plastic Mid-Index ( $n > 1.53$ )	PM
Plastic High-Index ( $n > 1.59$ )	PH
Plastic Ultra-Index ( $n > 1.65$ )	PU
Polycarbonate	PY
Other Plastic	OP

### 5.5 Treatment Types

<b>Filters</b>	<b>Literal</b>
Anti-Reflective Coating	AR
Anti-Slip	AS
Clear (DEFAULT)	NONE
High Energy Visible	HEV
Ink Stamp	IS
Mirrored	MIRR
Photochromic	PHOT
Polarized	POLR
Scratch-Resistant Coating	SR
Tinted	TINT
Color Code	See 5.1
UV-Inhibiting	UVRI

### 5.6 Usable Diameter Encroachment Type

<b>Filters</b>	<b>Literal</b>
Get specials	

## 6 Base Curve Charts

The following section will describe the representation of base curve charts within the Standard.

### 6.1 Describing Compressed Base Curve Charts

A regular base curve selection chart serves as an easy lookup for manual operator looking up the recommended base curve, given a particular prescription. It is less suited to the compressed transfer of the entirety of the underlying information contained in the base curve chart, and the following compression methodology is used within the Standard.

The following bottom fragment of a base curve chart is for a known add power, with the vertical axis representing the prescription sphere power and the horizontal axis representing the prescription cylinder power.

	-0	-0.25	-0.50	-0.75	-1.00	-1.25	-1.50	-1.75	-2.00	-2.25	-2.50
-9.50	1.30	1.30	1.30	0.50	0.50	0.50	0.50	0.50	0.50	0.50	0.50
-9.75	1.30	1.30	0.50	0.50	0.50	0.50	0.50	0.50	0.50	0.50	
-10.00	1.30	0.50	0.50	0.50	0.50	0.50	0.50	0.50	0.50		
-10.25	0.50	0.50	0.50	0.50	0.50	0.50	0.50	0.50			
-10.50	0.50	0.50	0.50	0.50	0.50	0.50	0.50				
-10.75	0.50	0.50	0.50	0.50	0.50	0.50					
-11.00	0.50	0.50	0.50	0.50	0.50						
-11.25	0.50	0.50	0.50	0.50							
-11.50	0.50	0.50	0.50								
-11.75	0.50	0.50									
-12.00	0.50										

Including each recommended base curve as an element identified by a specific add, sphere, and cylinder, would be possible but unrecommended due to the

number of elements. Instead, the above chart can be represented in the following form.

Add	Sphere	Cylinder	Base	Min	Max
0	-12.00	-0.12	null	null	null
0	-12.00	0.00	0.50	0.50	0.50
0	-11.75	-0.37	null	null	null
0	-11.75	0.00	0.50	0.50	0.50
0	-11.50	-0.62	null	null	null
0	-11.50	0.00	0.50	0.50	0.50
0	-11.25	-0.87	null	null	null
0	-11.25	0.00	0.50	0.50	0.50
0	-11.00	-1.12	null	null	null
0	-11.00	0.00	0.50	0.50	0.50
0	-10.75	-1.37	null	null	null
0	-10.75	0.00	0.50	0.50	0.50
0	-10.50	-1.62	null	null	null
0	-10.50	0.00	0.50	0.50	0.50
0	-10.25	-1.87	null	null	null
0	-10.25	0.00	0.50	0.50	0.50
0	-10.00	-2.12	null	null	null
0	-10.00	-0.12	0.50	0.50	0.50
0	-10.00	0.00	1.30	1.30	1.30
0	-9.75	-2.37	null	null	null
0	-9.75	-0.37	0.50	0.50	0.50
0	-9.75	0.00	1.30	1.30	1.30
0	-9.50	-2.62	null	null	null
0	-9.50	-0.62	0.50	0.50	0.50
0	-9.50	0.00	1.30	1.30	1.30

For the sphere power of -9.50, the initial base curve chart represented selection using 11 elements, while the condensed version does so with three records. Reading the condensed chart uses the following methodology. For a given prescription, you use the set of records for a given add power, ordered by ascending sphere and cylinder power. The sphere and cylinder values are read

as 'up to', so that if you have a prescription with a sphere power of -11.50, a cylinder power of -0.50, and an add power of 0, use the following steps:

- 1) Order the records for the add power by ascending sphere and cylinder power.
- 2) Start at the first record that is so ordered.
- 3) Is my prescription sphere power greater than the sphere power in the record?
- 4) If so, move to the next record and return to step 3. If there is no next record, this prescription has no recommended base curve.
- 5) If not, is my prescription cylinder power greater than the cylinder power in the record?
- 6) If so, move to the next record and return to step 3. If there is no next record, this prescription has no recommended base curve.
- 7) If not, then this record contains the recommended base curve. If the base curve power is null, then there is no base curve recommended for this prescription.

## 6.2 Representation of Compressed Base Curve Charts in the Standard

The formatting of the compressed base curve chart within the Standard is as follows, using the example chart fragment from 6.1. The Base Curve Chart object has an ID, and a collection named 'Adds'. Adds is a collection of objects, where each object contains the base curve chart values for a single add power. The add power that applies is within the range specified between the 'MinAdd' and 'MaxAdd' values, inclusive. For a single vision, the add power range will be 0.00 to 0.00. The lines for that add power are in the 'Lines' collection of strings, where each string corresponds to one record in the compressed base curve chart. The sphere, cylinder, and base curve values are all represented as \*100. If the fourth and fifth values are not present in a given line (the base curve min and max recommended values), they are presumed to equal the third value.

```
<BaseCurveCharts>
  <BaseCurveChart>
    <ID>46c4227b-eb26-44da-a785-4a2d2fcdc296</ID>
    <Adds>
      <Add>
        <MinAdd>0.75</MinAdd>
        <MaxAdd>4.00</MaxAdd>
        <Lines>
          <Line>-1200, -12, null</Line>
          <Line>-1200, 0, 50</Line>
```



```
<Line>-1175, -37, null<Line>
<Line>-1175, 0, 50<Line>
<Line>-1150, -62, null<Line>
<Line>-1150, 0, 50<Line>
<Line>-1125, -87, null<Line>
<Line>-1125, 0, 50<Line>
<Line>-1100, -112, null<Line>
<Line>-1100, 0, 50<Line>
<Line>-1075, -137, null<Line>
<Line>-1075, 0, 50<Line>
<Line>-1050, -162, null<Line>
<Line>-1050, 0, 50<Line>
<Line>-1025, -187, null<Line>
<Line>-1025, 0, 50<Line>
<Line>-1000, -212, null<Line>
<Line>-1000, -12, 50<Line>
<Line>-1000, 0, 130<Line>
<Line>-975, -237, null<Line>
<Line>-975, -37, 50<Line>
<Line>-975, 0, 130<Line>
<Line>-950, -262, null<Line>
<Line>-950, -62, 50<Line>
<Line>-950, 0, 130<Line>
...etc...
</Lines>
</Add>
</Adds>
<BaseCurveChart>
</BaseCurveCharts>
```

## 7 Describing the Geometry of Non-Spherical Surfaces

The geometry of non-spherical surfaces, including aspheric and progressive addition lens surfaces, shall be described using sag height data as specified below. Please note that the format described below applies specifically to sag height data provided in the Standard.

### 7.1 Guidelines for describing the geometry of non-spherical surfaces

The following data fields shall be provided in the order shown below. The field's label is provided, as well as a description / definition of the field, the type of entry data that should be supplied in the field, and any *literal* entries that should appear in the field. Certain fields may not be applicable for all lens styles, and should be left blank (that is, “,”). Fields that shall generally require an entry for most, though not necessarily all, spectacle lenses of any style or type have been indicated in the “?” column with the letter ‘M’ for *mandatory*. For instance, the **Add** and **Angle** fields are not applicable to *rotationally-symmetrical* surfaces, like single vision lenses.

#	?	Field Label	Description / Definition	Literals	Data Type
1	M	Base	Nominal base curve		Numeric, 2-decimal
2		Add	Add power (when applicable)		Numeric, 2-decimal
3	M	Radius	Incremental radius (mm)		Numeric, 2-decimal
4		Angle	Incremental angle (°), □000		Numeric, 2-decimal
5	M	Sag	Sag height at radius and angle		Numeric, 2-decimal

#### 7.1.1 Sag height data for general (non-rotationally-symmetrical) surfaces

General (or *non-rotationally-symmetrical*) surfaces, like those used for progressive addition lenses, require both radius and angular sag data. In the case of multifocal or progressive lenses whose sag height data vary from add power to add power, the sag height data for each individual add power are also required. The hierarchy of levels for this data shall be:

1. For each base curve, add power (when applicable), and radius, sag heights for every angle
2. For each base curve and add power, sag heights for every radius—at every angle
3. For each base curve, sag heights for every add power—at every radius and angle

Starting with the lowest nominal base curve, add power, incremental radius, and incremental angle value, the sag height data shall be provided in the following tabular format:

Base	Add	Radius	Angle	Sag
1 <sup>st</sup> Base	1 <sup>st</sup> Add	1 <sup>st</sup> Radius	1 <sup>st</sup> Angle	Sag Height
1 <sup>st</sup> Base	1 <sup>st</sup> Add	1 <sup>st</sup> Radius	n <sup>th</sup> Angle	Sag Height
1 <sup>st</sup> Base	1 <sup>st</sup> Add	n <sup>th</sup> Radius	1 <sup>st</sup> Angle	Sag Height
1 <sup>st</sup> Base	1 <sup>st</sup> Add	n <sup>th</sup> Radius	n <sup>th</sup> Angle	Sag Height
1 <sup>st</sup> Base	n <sup>th</sup> Add	1 <sup>st</sup> Radius	1 <sup>st</sup> Angle	Sag Height
1 <sup>st</sup> Base	n <sup>th</sup> Add	1 <sup>st</sup> Radius	n <sup>th</sup> Angle	Sag Height
1 <sup>st</sup> Base	n <sup>th</sup> Add	n <sup>th</sup> Radius	1 <sup>st</sup> Angle	Sag Height
1 <sup>st</sup> Base	n <sup>th</sup> Add	n <sup>th</sup> Radius	n <sup>th</sup> Angle	Sag Height
n <sup>th</sup> Base	1 <sup>st</sup> Add	1 <sup>st</sup> Radius	1 <sup>st</sup> Angle	Sag Height
n <sup>th</sup> Base	1 <sup>st</sup> Add	1 <sup>st</sup> Radius	n <sup>th</sup> Angle	Sag Height
n <sup>th</sup> Base	1 <sup>st</sup> Add	n <sup>th</sup> Radius	1 <sup>st</sup> Angle	Sag Height
n <sup>th</sup> Base	1 <sup>st</sup> Add	n <sup>th</sup> Radius	n <sup>th</sup> Angle	Sag Height
n <sup>th</sup> Base	n <sup>th</sup> Add	1 <sup>st</sup> Radius	1 <sup>st</sup> Angle	Sag Height
n <sup>th</sup> Base	n <sup>th</sup> Add	1 <sup>st</sup> Radius	n <sup>th</sup> Angle	Sag Height
n <sup>th</sup> Base	n <sup>th</sup> Add	n <sup>th</sup> Radius	1 <sup>st</sup> Angle	Sag Height
n <sup>th</sup> Base	n <sup>th</sup> Add	n <sup>th</sup> Radius	n <sup>th</sup> Angle	Sag Height

Where ‘n’ simply represents the any subsequent values above 1.

7.1.2 Sag height data for rotationally-symmetrical surfaces

*Rotationally-symmetrical* surfaces, like those used for single vision aspheric lenses, require only radial sag data. In this case, the **Angle** and **Add** fields should be left blank (i.e., “,”). The hierarchy of levels for this data shall be:

1. For each base, sag heights at every radius

Starting with the lowest nominal base curve and incremental radius, the sag height data shall be provided in the following tabular format:

Base	Add	Radius	Angle	Sag
1 <sup>st</sup> Base		1 <sup>st</sup> Radius		Sag Height
1 <sup>st</sup> Base		n <sup>th</sup> Radius		Sag Height
N <sup>th</sup> Base		1 <sup>st</sup> Radius		Sag Height
N <sup>th</sup> Base		n <sup>th</sup> Radius		Sag Height

## 7.2 Chart example for describing the geometry of non-spherical surfaces

The following represents what a file fragment of sag data might look like for a progressive addition lens with a 6.00 base curve and a +1.00 add progressive power:

Base,	Add,	Radius,	Angle,	Sag,
6.00,	1.00,	15.0,	0,	3.17,
6.00,	1.00,	15.0,	15,	3.56,
6.00,	1.00,	15.0,	...	...
6.00,	1.00,	17.5,	0,	4.01,
6.00,	1.00,	17.5,	...	...
6.00,	1.00,	...	...	...
6.00,	1.25,	15.0,	0,	3.20,
6.00,	1.25,	15.0,	...	...
6.00,	1.25,	17.5,	0,	4.16,
6.00,	1.25,	17.5,	...	...
6.00,	1.25,	...	...	...
6.00,	...	...	...	...
...	...	...	...	...

## 7.3 Representation of Sag Chart data in the Standard

The formatting of the sag chart within the Standard is as follows. The Sag Chart object has an ID, and a collection of strings named 'Lines', where each string corresponds to one record in the sag chart. The base, add, radius, and sag values are all represented as \*100.

```
<SagCharts>
```

```
<SagChart>
```

```
<ID>b2598bd8-063e-41cd-a3ad-50f8daf0e3d5</ID>
```

```
<Lines>
```

```
<Line>600,100,1500,0,317</Line>
```

```
<Line>600,100,1500,15,356</Line>
```

```
<Line>600,100,1500,....,....</Line>
```

```
<Line>600,100,1750,0,401</Line>
```

```
<Line>###,###,###,###,###</Line>
```

```
<Line>###,###,###,###,###</Line>
```

```
</Lines>
```

&lt;/SagChart&gt;

&lt;/SagCharts&gt;

#### 7.4 Guidelines for specifying sag height data

Each sag value is the height of the lens surface at a given semi-diameter (or radius)  $r$ , as measured perpendicularly from a plane tangent to the prism reference point of the lens design. This has been illustrated in Figure 17. To describe a non-spherical surface to an acceptable level of accuracy for processing and thickness calculations, multiple sag heights through a given *section* of the lens surface are required. Here, a **section** is defined as a plane perpendicular to the tangent plane and containing a given meridian (from  $0^\circ$  to  $360^\circ$ ) of the lens. For *non-rotationally-symmetrical* surfaces, whose sag heights vary from meridian to meridian, data from multiple sections are also required.

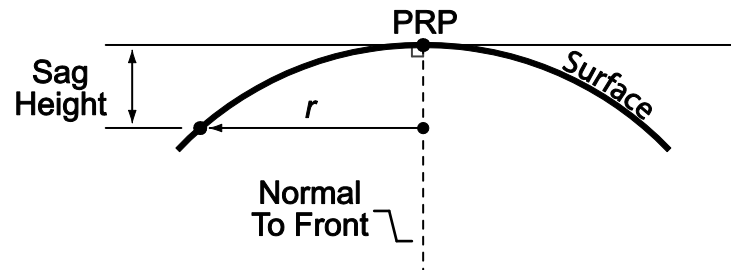

**Figure 17** Sag height of lens surface at the semi-diameter  $r$

Numeric values and text should adhere to the sign convention developed in Section 2.2.

##### 7.4.1 For rotationally-symmetrical surfaces:

Since sag values through each meridional section of rotationally-symmetrical surfaces are equal, no particular orientation needs to be expressed or implied.

The radial (or tangential) sag values of rotationally-symmetrical surfaces shall be given in 2.5-mm radial increments, beginning 15.0 mm from the prism reference point (PRP) of the lens design. See Figure 18.

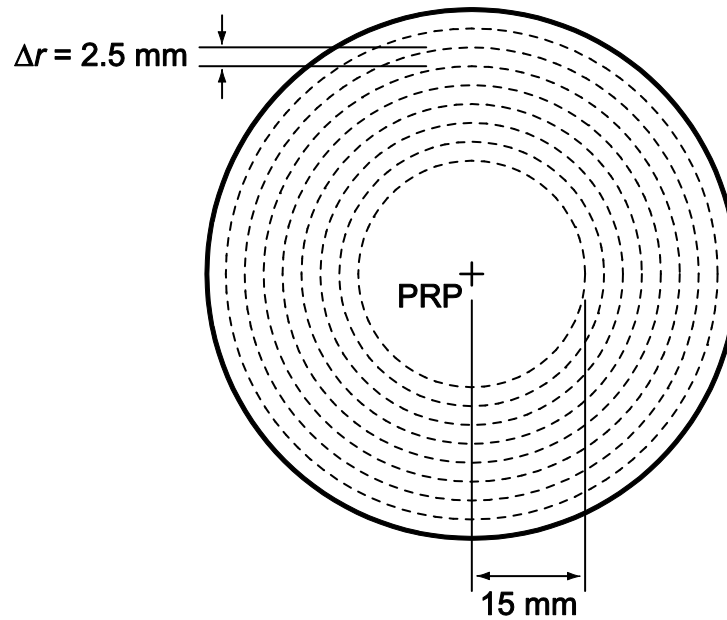
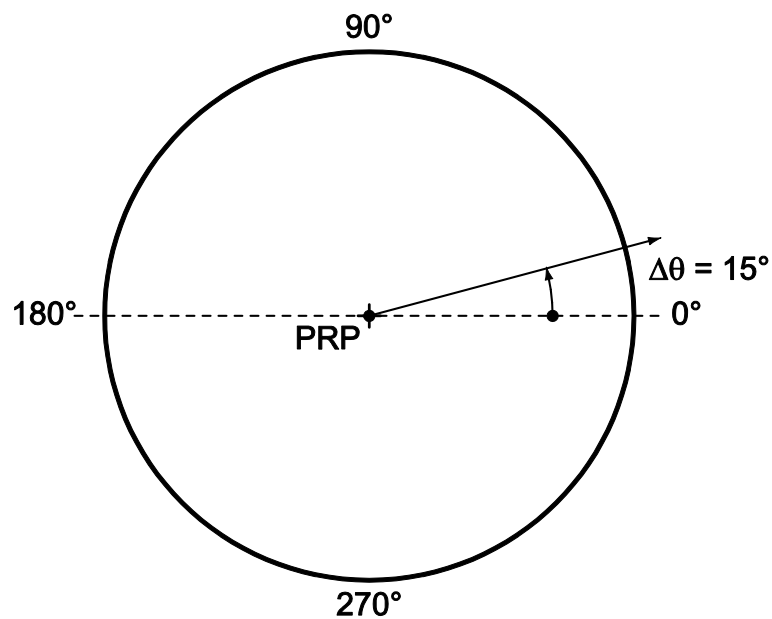

**Figure 18** Radial measurement increments ( $\Delta r$ ) for surfaces

7.4.2 For non-rotationally-symmetrical surfaces:

The sag heights of non-rotationally symmetrical surfaces shall be given for meridional sections in  $15^\circ$  angular increments, beginning from the  $000^\circ$  (nasal) meridian of the *right* lens and terminating at the  $345^\circ$  meridian. This has been illustrated in Figure 19.

The radial (or tangential) sag heights through each meridional section of non-rotationally-symmetrical surfaces shall be given in 2.5-mm radial increments, beginning 15.0 mm from the prism reference point (PRP) of the lens design.



**Figure 19** Angular measurement increments ( $\Delta\theta$ ) for general (non-rotationally-symmetrical) surfaces